



2005/2006

---

SHOOTING CLOTHING  
AND TARGET RIFLES ACCESSORIES  
FOR TARGET SHOOTERS.

No, don't worry; we have not switched to the „animal area“. But we can learn a lot from Mother Nature. „Nature as our Idol“ – is our motto. Many things we try to handle technically today have been shown by nature for years. We have understood and you have the advantage.

A hawk's eyesight, an elephant's stability, a chameleon's adaptability and a leopard's quick ability to react – these are only a few of the characteristics champions are made of. You are up to it and we supply you with the appropriate equipment.

Shooting technology, mental training and fitness are important. However, a very important ingredient to success is shooting apparel.

If you do not feel comfortable in your shooting clothing, and the material in your shooting clothing is not up to your expectations, a shooter can experience negative influences that cannot be compensated by any training.

This is why many German, European, World and Olympic Champions rely on ahg-Anschütz products. I would like to take this occasion to thank the target shooters and coaches all over the world who have assisted in the development of our ahg-range and thus also have contributed to the composition and completion of this catalogue.

I also would ask you to understand that we could not include the picture of every shooter who successfully uses our products.



Uwe Anschütz  
President of  
ahg-Anschütz Handels GmbH



### ahg-Shooting Clothing

- 03 ahg-News.
- 04-12 ahg-Shooting Jackets, Pants and Button horn.
- 13-15 ahg-Underwear.
- 16-19 ahg-Boots, Shoe Sole Tree, Inner Soles, Socks und Laces.
- 20-23 ahg-Shooting Gloves.
- 24-25 ahg-Shooting Caps and Headbands.
- 26 ahg-Kneeling Rolls.
- 27 ahg-Shooting Slings.
- 28 ahg-Weapon Safety Accessories.
- 29 ahg-Shooting Braces and Belts, Shooting glasses.



### ahg-Transport Cases / Cleaning Accessories

- 30-31 ahg-Gun Cases.
- 32 ahg-Transport Cases.
- 33-34 ahg-Soft Cases.
- 35 ahg-Cleaning-Sets, Cotton Wicks, Gun Sight Darkener and ahg-VFG-Cleaning Systems.



### ahg-Tripods / Spotting Scopes / Iris Apertures

- 36 ahg-Tripods.
- 37 ahg-Spotting Scopes and Nikon Systems.
- 38-41 ahg-Iris Apertures.
- 42 ahg-Accessories for Peepsights.
- 43-45 ahg-Iris Discs, Rear Sight and Adapter.



### ahg-Accessories

- 46-47 ahg-Sight-Track, Handstop, Stabilizer, ahg-Spirit Level and Barrel Weight.
- 48-49 ahg-Rear Sight Knob Set, Aluminium Balls for Bolt Handle, ahg-High Sight Block, Adjustable off set sight, ahg-Rear Sight Rail, Wedge and ahg-Cheek piece mechanism.
- 50-51 ahg-Handstop, Palm Rest, Wedge, Stock Weight, ahg-BI-POD, Trigger Shoe, Monoframe and Sight Raiser Block.
- 52 ahg-Trigger Pressure Gauge, Uni Tool, Velocimeter, ahg-Flip-up Blinder and Torque Wrench.
- 53 ahg-Jäggi-Nova-Shooting Glasses.
- 54 ahg-Safety-Box, Key Pendant, Pins, Pellet-Box, ahg-Pellets, Back-Pack and ahg-Protection Wrapping for Cartridges.
- 55 ahg-Bag.
- 56 MEC Accessories.
- 57 ahg-F27A Challenger.



### ANSCHÜTZ-Line

- 58-59 ANSCHÜTZ-Target Rifles and Air Rifles.
- 60 ANSCHÜTZ-Accessories. Sight Sets, Front Sight Insert Set and Rear Sight.
- 61 High sight Block for Sighting Line, Pro-Grip, Handstop, Sighting Line Extension, Air Release Valve, Adapter, Barrel Weight and Weight Ring.
- 62 Forend Raiser Block, Quick clamping, Hook Butt Plates, Refill Adapter, Spirit Levels, Hook Plate Carrier, Globe Front Sight, BI-POD and High Pressure Compressor.
- 63 The best shooters of the world ...

## ahg-STICKER

just like a real hit.

### ahg-Sticker:

Stick them on the tank of your bike, your car, your window, your helmet.

The perfect illusion.



Art.-Nr.: 3000



Art.-Nr.: 3001



Art.-Nr.: 3002



Art.-Nr.: 3003



Art.-Nr.: 3004







**Art.-Nr.: 167**  
Page 3



**Art.-Nr.: 156**  
Page 13

**Art.-Nr.: 9795**  
Page 50



03

**Art.-Nr.: 119**  
Page 21



**Art.-Nr.: 118**  
Page 20



**Art.-Nr.: 301**  
Page 24

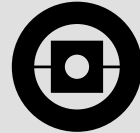

**Art.-Nr.: 9601**  
Page 39



**Art.-Nr.: 6926**  
Page 51



**Art.-Nr.: 9450**  
Page 49



**Art.-Nr.: 1025**  
Page 49

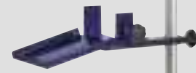

**Art.-Nr.: 451**  
Page 36



**Art.-Nr.: 9499**  
Page 42



**Art.-Nr.: 9497**  
Page 42



**Art.-Nr.: 1320**  
Page 61



**Art.-Nr.: 457**  
Page 36





# ahg-STENVAAG DESIGN Mod. Scorpion

the top class shooting jackets and pants  
for shooters demanding high quality

## ahg-STENVAAG DESIGN:

ahg-Anschütz has taken over the manufacture and sale of the well-known Stenvaag-Design Collection.

In close co-operation with the Norwegian National shooter Harald Stenvaag the Scorpion Collection was developed on the basis of the popular and successful Stenvaag-Design shooting jackets and pants.

The new Stenvaag collection mirrors the experience and the results of many World Championships as well as Olympic Games.



Made  
in  
GERMANY



**NEW!**



Shooting Glove  
**Art.-Nr.: 118**

Shooting Glove  
**Art.-Nr.: 119**

Shooting Jacket  
**Art.-Nr.: 167**







**WE RELY ON STENVAAG QUALITY**



05

**ahg-Shooting Jacket  
STENVAAG-DESIGN  
Scorpion:**

High-quality leather-canvas combination with TOP GRIP padding „Made in Germany“.

- The sleeve is put in twisted for the supporting arm to guaranty a repeatedly precise and tension free positioning in any kind of disciplines.
- Many possible adjustments in height and angle of the sling fastening optimize the power flow from the sling to the rifle in prone and kneeling position.
- Asymmetric shoulder cut with suede part reduces the uncomfortable creasing in the neck area when prone positioning.
- Adjustable shoulder straps allow controlled creasing for the best fit of the butt plate on the shoulder.
- Smartly used stretch material give this shooting jacket the necessary comfort when stabilizing for positioning.
- The leather-stretch material on the upper right arm avoids that tension, which can occur in this area, does not pass over to the back; this allows the shooter to stand comfortably when positioning.
- Coloured piping in the back give this jacket a sportive touch.

Material:  
58% cotton, 42% leather.  
Inner lining: 100% cotton.

**Art.-Nr.: 167**



Made in GERMANY

Stretch material at the left forearm avoids that the jacket touches the stock in the prone position. In addition the connection between jacket and glove is stabilized. Darts guarantee better fit to the waist in the standing position.

**ahg-Shooting Pants  
STENVAAG-DESIGN:**

- The Stenvaag Pants have 2 long 2-way zippers which can be opened from top or bottom when choosing different positions.
- The hook closure on the waistband and the Velcro closure on the right pants' leg allow individual adjustments e.g. small loss of or increase in weight of the shooter.
  - The stretch material at the end of the Velcro avoids pressure on thigh and waist.
  - The stretch material in the crotch and thigh enables to a wider foot posture in kneeling position.
  - The TOP GRIP padding avoids pressure pain in kneeling position.

Material Model 1:  
100% cotton.  
Inner lining: 100% cotton.

**Art.-Nr.: 139**

Same cut as mod. 139, hip and waist are made from double canvas, pants' legs from leather.

Material Model 2:  
20% cotton, 80% leather.  
Inner lining: 100% cotton.

**Art.-Nr.: 140**





# ahg-SPECIAL-COLOR

a pre-condition for top-class shooting

Made in GERMANY



06

## ahg-Shooting Jacket SPECIAL-COLOR:

- New back design and tailor fit for optimum contouring of the body.
- Stretch inserts allow easy bending of the arms.
- Shoulder sling for prone shooting.
- Variable length adjustment of sling holder.
- Individual adjustment of shooting jacket by buttons with screws.
- TOP GRIP padding prevents any slipping in position.
- Available in all ahg-color combinations according to your wishes, no extra charge.

Material:  
100% cotton.  
Inner lining: 100% cotton.

Canvas colors:  
For your individual color combination see folding page "Colors".

Black-turquoise-lilac.  
**Art.-Nr.: 17013**

Black-blue-white.  
**Art.-Nr.: 17016**

High quality double canvas jacket with TOP GRIP padding "Made in Germany". Due to the new high tech back design this jacket offers an optimum fitting in all positions.



Shooting Glove  
**Art.-Nr.: 125**

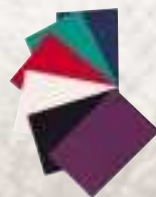

Shooting Pants  
**Art.-Nr.: 14116**

Shooting Boot  
**Art.-Nr.: 133 Color**

## ahg-Shooting Pants

SPECIAL and CHAMPION

- the top models

In order to comply with the most important functions of shooting pants, these pants were designed as follows:

- The yoke is especially fitted at the waist and thus guarantees the best fit in the spinal area.
- 2 long 2-way zippers which can be opened from top or bottom for different positioning.
- The hook closure on the waistband and the Velcro closure on the right pants' leg allow individual adjustments e.g. small loss of/increase in weight of the shooter.
- The stretch material at the end of the Velcro avoid pressure on thigh and waist.
- The stretch material in the crotch and thigh enables to a wider foot posture in kneeling position.
- The TOP GRIP padding avoids pressure pain in kneeling position.

### ahg-Shooting Pants SPECIAL:

Material:  
100% cotton.  
Inner lining: 100% cotton.  
Black-blue.

**Art.-Nr.: 14116**

### ahg-Shooting Pants CHAMPION LEDER:

Material:  
100% leather.  
Inner lining: 100% cotton.

**Art.-Nr.: 142**



Shooting Jacket  
**Art.-Nr.: 17016**

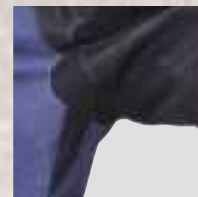



# ahg-Shooting Jacket ECONOMY

high quality design

## ahg-Shooting Jacket ECONOMY:

High quality double canvas shooting jacket for a top price.

- The left side is provided with a leather application of suede to obtain an even stronger adhesion with anti-slip rubber application at the sleeve.
- Two straps at the back of the shoulder to prevent the material bulge in prone position.
- Excellent fit and stability due to extra fitted cut, especially at shoulders, waist and column.
- Individual fitting of the jacket by aluminium buttons with screw.
- New sling fixing.

Material:  
85% cotton, 15% leather.  
Inner lining: 100% cotton.

Available in standard sizes:  
- 44 to 60 (men),  
- 36 to 48 (women).

**Art.-Nr.: 174**



07



## ahg-BUTTON HORN:

- Absolutely new on the market.
- For easy opening and closing of the shooting jacket.
  - For every pocket.
  - Top Design.

**Art.-Nr.: 1202**



## TOP GRIP SHEET:

The ahg-TOP GRIP Sheet offers best conditions for kneeling and prone position.

- Dimensions: 950 x 900 mm.
- Thickness: 2 mm.

**Art.-Nr.: 191**

## ahg-TOP GRIP padding for shooting pants:

In black, 1 set.

**Art.-Nr.: 140-T**

## ahg-TOP GRIP padding for shooting jacket:

In black, 1 set.

**Art.-Nr.: 180-T**



# ahg-STANDARD

the first set -  
for clubs and beginners

## ahg-Shooting Jacket STANDARD:

A low priced canvas jacket, equipped with the prime features of our shooting jackets:

- Stretch insert in the arm pit.
- Sling holder.
- Shoulder straps.
- Anti-slip rubber padding.

Available in all common sizes as well as stocky and slim sizes.  
No tailoring.

Material:  
100% cotton.  
Inner lining: 100% cotton.

**Art.-Nr.: 160** ▶



Also available in  
left hand version.



Shooting Boot

**Art.-Nr.: 133 Color**

Shooting Vest

**Art.-Nr.: 194**



Shooting Glove

**Art.-Nr.: 125**

## ahg-Shooting Pants STANDARD:



Inexpensive pants made of double canvas, suitable for all three shooting positions and offering a considerable support to the shooter.

Available in the sizes:

- Men's 42-64.
- Stocky and slim sizes 25-34; 96-110.
- Women's 36-50.
- Teenager sizes 158, 164, 176.

No custom-made tailoring.

Material:  
100% cotton.  
Inner lining: 100% cotton.

**Art.-Nr.: 144**





10% surcharge on custom-made garments:  
 men's normal sizes 56 and up,  
 stocky and slim sizes 28 and up as well as ladies' sizes 48D and up  
 20% surcharge on shooting jackets with a chest circumference of 130 cm and up  
 No refund/exchange for custom-made garments

Also available in  
 left hand version.



### ahg-Shooting Jacket STANDARD:

This model ist now available also in suede-  
 canvas combination.

Available in the sizes:

- Men's 42-64.
  - Stocky and slim sizes 25-34; 96-110.
  - Women's 36-50.
  - Teenager sizes 158, 164, 176.
- No custom-made tailoring.

Material:  
 47% cotton, 53% leather.  
 Inner lining: 100% cotton.

**Art.-Nr.: 165**



09



Shooting Glove

**Art.-Nr.: 125**

- The complete left side is made of suede  
 for better adhesion to the anti-slip rubber  
 padding for the standing position.

- Sling holder on the left sleeve for exact,  
 individual regulations of the target sling.
- Two straps at the back of the shoulder  
 to prevent the material bulge in prone  
 position.



▲  
 ahg-BUTTONS with screw:

**Art.-Nr.: 199**

Shooting Glove

**Art.-Nr.: 133 Color**



# ahg-SHOOTING JACKET PROFESSIONAL

for professional shooters

ahg-shooting jackets are jackets for top class shooters, which especially comply with the in-creased requirements for prone, kneeling and standing position. Available in all common sizes, also for left hand shooters.

ahg-shooting jackets can also be delivered according to special tailoring. Please ask for our measurement card.

## ahg-Shooting Jacket PROFESSIONAL:

This jacket has been developed for the best shooters and those who want to become one. The shoulders are equipped with leather material for a perfect fit.

- Stretch material at the left forearm avoids that the jacket touches the stock in the prone position. In addition the connection between jacket and glove is stabilized.
- Excellent fit and stability due to extra fitted cut, especially at shoulders, waist and column.
- Darts guarantee better fit to the waist in the standing position.
- TOP GRIP material.
- Optimum supporting function due to the use of high quality and stabilizing materials.
- A new button system guarantees a better fit in the kneeling and prone position.

Made  
in  
GERMANY



Material:  
52% cotton, 48% leather.  
Inner Lining: 100% cotton.

Colors:  
For your individual color combination, please see folding page "Colors": Simply unfold the color card and decide on your personal combination.

Blue-black-yellow.

**Art.-Nr.: 175**





# ahg-PRO-TECH

a top jacket at a top price

## ahg-Shooting Jacket PRO-TECH:

High quality shooting jacket at a top price.  
- Left side made completely of suede for better adhesion to anti slip padding of sleeve in standing position.  
- Two straps on the left shoulder prevent the material bulge in prone position.

- Better performance because of new designed waist cut.
- Individual fitting of the jacket by aluminium buttons with screw.
- New sling fixing.

Material:  
64% cotton, 36% leather.  
Inner lining: 100% cotton.

Available in standard sizes  
- 44 to 60 (men),  
- 36 to 48 (women).

**Art.-Nr.: 177**



## ahg-Shooting Pants ECONOMY:

The new pants Economy are made of strong double canvas. Waistband and left leg are provided with velcro closures and thus can easily be adjusted to your body. Pants with a favourable cost effectiveness!

Material:  
100 % cotton.  
Inner lining: 100 % cotton.  
Padding: Rubber material.

**Art.-Nr.: 147**



## ahg-ALU buttons:

- Set with 5 buttons.
- Extra flat.

**Art.-Nr.: 189**



11



# ahg-SHOOTING Jacket Bench Rest

the thing for benchrest shooters

12

## ◀ ahg-Shooting Jacket Bench Rest: ▶

- For bench rest shooters.
- For right and left hand shooters.
- Double canvas in the back supports and stabilizes the position.
- TOP GRIP padding at both shoulders prevents the rifle from slipping and allows the use of the jacket for right and left hand shooters.
- Buttons with screws for individual adjustment of the jacket.
- Special button-facing made from leather for an easy and comfortable buttoning of the jacket.

**Art.-Nr.: 187**

Material:  
100% cotton.  
Inner lining: 100% cotton.



Made in GERMANY

## ◀ ahg-Shooting Jacket Bench Rest:

- Like shooting jacket BENCH REST but of artificial leather black.

Material:  
Upper material: Artificial leather/ PUR.  
Inner lining: 100% cotton.

**Art.-Nr.: 188**



## ▲ ahg-HOOKS:

- For shooting slings.

**Art.-Nr.: 336**





# ahg-SHOOTING UNDERWEAR

temperature regulating underwear

## ahg-Underwear COLD WINNER:

The COLDWINNER™ is now part of the new generation of patented technical fabrics with multiple functions. Made of the combination of 3 different materials, the COLDWINNER™ enables to fully protect the body and regulate its temperature. Sweat is immediately evacuated outside the garment, where it directly evaporates in the air. The body is thus kept dry and warm. Tests made in Canada and Europe in daily and extreme conditions (temperatures between +25°C and -22°C) have confirmed all the technical underwear qualities. These various tests prove the COLDWINNER™ efficiency and its necessity to be worn in the following sport activities: Cycling, Shooting-Sport, Mountain Bike, Crosscountry Ski, Alpine Ski, Ski-Doo, Climbing, Trekking, Sailing, etc. as well as in the everyday life. The COLDWINNER™ underwear needs to be worn close-to-the-body, on the bare skin, to get a maximum efficiency. You can wear it all year long, considering the weather conditions and the temperature variations. Despite its relative heaviness, it does bring an absolute comfort through its lightness on the skin.

Thanks to its technical structure, the COLDWINNER™ has become the thermoregulating underwear the most appropriate to all conditions.

Available in sizes: XS, S, M, L, XL, XXL.  
ahg-undershirt long.

**Art.-Nr.: 154**

ahg-underpants.

**Art.-Nr.: 155**



**COLD  
WINNER™**   
patent pending



## ahg-Shooting Vest COLD WINNER:

The proven and tested COLD WINNER underwear (art. 154 and 155) is now also available as shooting vest. The difference to the normal underwear shows in the part of the upper body of the vest, where a disturbing pressure is felt; there the material is used in twofold (2,2 mm instead of 1,1). More material consequently enlarges the volume of the vest and thus wears even more comfortably. The 2-way-zipper can be opened from the bottom; especially when shooting in kneeling position, this avoids tightness when positioning.

Thanks to its high-tech structure COLD WINNER is the one thermo-regulating underwear the most appropriate for all conditions.

Available in sizes XS, S, M, L, XL, XXL.

**Art.-Nr.: 156**



13



# ahg-SHOOTING UNDERWEAR

for a good feeling on the skin

14

## ahg-SHOOTING UNDERWEAR:

Functional and thermo underwear made of Tactel aquador. The ideal underwear for sports and leisure time – suitable not only for shooting:

Tactel aquador is a unique textile system with highly effective humidity management. It offers maximum pleasure to the skin. Tactel aquador is a unique two-layer textile system. The inner tactel layer leads the humidity away from the skin into the outer cotton layer where it evaporates.

- ▼ - With stand-up collar and zipper.
- Humidity regulation.
- Temperature regulation.
- Breathable.
- Pleasant to the skin.
- Stable in shape, elastic.
- Easy care.

Material:  
65 % cotton, 35% polyamide.

Undershirt long sleeves.  
Sizes: S, M, L, XL, XXL.

**Art.-Nr.: 152**

Underpants, long.  
Sizes: XS, S, M, L, XL, XXL.

**Art.-Nr.: 153**

## ahg-SHOOTING VESTS

in current colors:

It is not only the shooting jacket which is important for the shooter but also the underwear.

The ahg-shooting vest has the following advantages which you will feel at once:

- Perfect fit on elbows and shoulders without pleats.
- No seams at the shoulder.
- Padded elbows especially suited for prone shooting.
- Zipper which can be opened on both sides for kneeling position.
- Back with air holes for temperature compensation.

Material:  
50% cotton, 50% polyacryl.

Sizes:  
XS, S, M, L, XL, XXL.



*Stenwalde*  
**DESIGN**







**NEW!**



**ahg-SHOOTING VEST  
LONG SLEEVES:**

Blue / black.

**Art.-Nr.: 194**

**ahg-SHOOTING VEST ▶  
without sleeves:**

- Especially for shooters who want more movability of arms and shoulders without losing the effects of a shooting vest.
- Excellent for bench rest shooters who want more volume and support under their bench rest jacket.

**Art.-Nr.: 197**

**NEW!**

**◀ ahg-SHOOTING VEST  
LONG SLEEVES:**

Silver / black.

**Art.-Nr.: 193**



# ahg-STENVAAG DESIGN

if you need reliable boots



## ahg-SHOOTING BOOTS STENVAAG:

We have once again improved our shooting boots model STENVAAG based on an intensive co-operation with the top-class shooter Harald Stenvaag and the world-wide famous boot manufacturing company Meindl. High-tech materials created boots which are highly suitable for all shooting positions.

A new buckling system on the upper stock enables an optimal stability and quick and simple snug fitting of the stock diameters. The new directing on the Velcro causes it to be less (35 %) used.

**1** Well padded tongues made of perforated material avoid pressure and guarantee a perfect air circulation.

**2** Perforation holes in the outer shaft plus porous padding foames allow comforting air circulation.

**3** The toe top is made of soft, elastic rubber with a strong grip in order to fix the position of the boot in the kneeling position.

**4** Velcro closure to ensure a snug fit.

**5** The new system offers a pressure-free fixation of the foot without obstructing blood circulation. The two-piece, non-flexible nylon string makes a perfect fit, the padding prevents pressure build-up. Being an integral part of the shaft and furnished with an inner and

outer set of hooks this system provides a two-layer lacing.

The deeper hook which is connected to the Digafix-system improves also the sitting position of the heels.

**6** Toe- and heel-cap are made of extremely stiff thermoplastic material.

**7** The anti-skid profile of the rubber sole ensures a steady foot-hold.

**8** Grip control for a maximum support in kneeling position.

**9** Grip Control supports the hold while in kneeling position.

Available in sizes:  
From 35 to 49 (2 1/2 to 13).

**Art.-Nr.: 130**



Material: leather.  
Sole: India rubber.





# ahg-STENVAAG DESIGN „LADY“

high tech lady shooting boots

## ahg-SHOOTING BOOTS STENVAAG LADY:

Considering the anatomical differences of women's and men's feet we developed shooting boots especially for women which differ from the men's model in the following features:

- Narrower last thus accounting for anatomical differences.
- New, fashionable color combinations.
- With new Velcro system.

Available in sizes:  
From 35 to 42 (2 1/2 to 8).

**Art.-Nr.: 131**



Material: leather.  
Sole: India rubber.



17

# ahg-SHOOTING BOOTS „easy“

safety for every foot



Material: leather.  
Sole: India rubber.



## ahg-SHOOTING BOOTS „easy“:

- Top price shooting boots in the usual Meindl quality.
- Anatomically shaped inner sole.
- Optimum workmanship for stability.
- Stable, straight sole for safe standing.

Available in sizes:  
From 37 to 47 (3 1/2 to 12).

**Art.-Nr.: 132**

Accessories like shoe sole  
trees etc. see page 19.



18

# ahg-SHOOTING BOOTS

if you need reliable boots

## ahg-SHOOTING BOOTS:

Shooting boots newly designed according to the expectations of top shooters.

- Well padded tongues absorb pressure which might cause discomfort.
- The cut of the body allows lacing up to the tips and thus gives every foot a customized fit.
- The front leather toe cap is shaped to keep it from touching the floor when in the kneeling position.
- The extra firm anti-slip sole is also slightly concave on the inner side to provide an extra solid support for the standing position.
- The back edge of the sole is slightly slanting to improve seating in the kneeling position.
- The stability of the shank in combination with the solid leather cap gives firm support to the foot.
- Beautiful finish inside and outside gives the boots a sports fashion touch.
- The anatomically supportive inner sole prevents foot fatigue during competition.



Available in sizes:  
From 35 to 51 (2 1/2 to 15).

Art.-Nr.: 133



Material: leather.  
Sole: India rubber.



Material: leather.  
Sole: India rubber.

## ahg-SHOOTING BOOTS:

In fashionable color combinations:  
Version like our successful model 133,  
but shank leather anthracite, suede blue.

Art.-Nr.: 133 Color





# ahg-SHOOTING BOOTS ALLROUND

a multi talent

## ahg-SHOOTING BOOTS ALLROUND: ▶

This new ahg-shoe with a sporty look is especially designed for all shooting disciplines like running target, trap, skeet, pistol and all shotgun shooting.

- Well padded tongues absorb pressure which might cause discomfort.
- The extra firm anti-slip sole is also slightly concave on the inner side to provide an extra solid support for the standing position.
- Beautiful finish inside and outside gives the boots a sports fashion touch.
- The anatomically shaped inner sole prevents foot fatigue during competition.

Available in sizes:  
From 36 to 48 (3 to 12).

**Art.-Nr.: 134**



Material: leather.  
Sole: India rubber.

## ahg-SHOOTING BOOTS ALLROUND:

In fashionable color combinations: Version like our successful model 134, but shank leather petrol blue, suede mint and bordeaux.

**Art.-Nr.: 134 Color**

Material: leather.  
Sole: India rubber.



19



## ▲ Meindl SPECIAL-CLIMATE-SOCKS:

Sizes: S = 36-39  
M = 40-43  
L = 44-47

Color: black.  
Material:  
68 % Cool Max, 26% cotton,  
4% Polyamid, 2% Elasthan.

**Art.-Nr.: 133-1**



## ▲ ahg-LACES:

- For shooting boots: 1 set.

**Art.-Nr.: 133-2**



## ▲ ahg-SHOE SOLE TREE:

The ahg-shoe sole tree will prolong the life of your shooting boots and ensures constant flat soles for many years.

- Suitable for all common shooting boots.  
From size 36-50.

**Art.-Nr.: 136**

## ahg-INNER SOLES: ▶

Fit all ahg-shooting boots. Including adhesive padding. To support the foot to compensate anatomic defects.

**Art.-Nr.: 133-4**





# ahg-SHOOTING GLOVES

as individual as your personality



All shooting gloves correspond to the ISSF + DSB-Rules.

ahg-shooting gloves of various colors and materials. The individual glove for each personality and taste, but all models of high quality.

- Optimum fit.
- Comfortable cut.
- Anti-slip padding or TOP GRIP.
- Made according to DSB and ISSF-rules.

20

## ahg-CONTACT: ▶

A new glove developed by ahg-Anschütz which offers more contact to the gunsupporting hand, much freedom of movement and maximum padding. Thumb and forefinger are open to allow comfortable loading of the gun.

We have used a special soft leather and a breathable fleece material for a good regulation of temperature and reduction of perspiration.

Palm and back of the glove are equipped with a newly developed hard-wearing antislip padding for proper adjustment to the hand and non-slip positioning of the gun.

If required, the glove can be washed at 30° C.  
Sizes: XS, S, M, L, XL, XXL.



For right hand shooters.

**Art.-Nr.: 118**

For left hand shooters.

**Art.-Nr.: 118-L**

Material:  
46% leather, 50% polaire polyester, 4% rubber.  
Padding: 60% polyamid, 40% polyurethan.

## ahg-THERMO STAR: ▶

5-finger glove.  
The latest generation of shooting gloves from ahg-Anschütz. It offers you the advantages which become evident during competition:

- With the net material at the back of the hand and on the palm and with air ventilation holes at the fingers an optimum temperature circulation is reached to avoid excessive heat in the glove.
- Due to the use of latest high-tech materials the back of the hand is reinforced, the wrist is stabilized in addition.
- There is a damping material from the back of the hand to the palm. The pressure of the handstop is thus evenly distributed in prone position.
- TOP GRIP material avoids any sliding of the gun.

Sizes: XS, S, M, L, XL.

For right hand shooters only.

**Art.-Nr.: 127**



Material: 6% leather, 60% rubber, 6% rubber band, 20% PU und 8% polyamid.  
Inner lining: 34% wool, 33% viscose and 33% polyacryl.  
Padding: Top Grip.







### ahg-AIR MAX: ▶

- 5-finger glove. The top model for top shooters:
- Vertical slot on the back of the glove for easy bending.
  - Mesh material on back and palm for good regulation of temperature.
  - Stretch band on the wrist.
  - TOP GRIP padding.
  - Corresponding to ISSF + DSB-rules.
  - Color combination: black/red/silver.

Sizes: XS, S, M, L, XL.

For right hand shooters only.

**Art.-Nr.: 107**



Material: 70% polyamid (mesh), 20% artificial leather (PVC; PES) and 10% leather.  
 Inner lining: 34% wool, 33% viscose and 33% polyacryl.  
 Padding: Top Grip.

### ahg-PRO-TECH: ▶

- 5-finger glove.  
 Top model of the ahg-Collection:
- Cross slot at the back for better bending capacity of the fingers.
  - Ventilation patterns on the side back of the hand guarantee best air circulation.
  - Stretch band on wrist.
  - GRIP padding.
  - According to ISSF + DSB-rules.
  - Color: black-turquoise.

Sizes: XS, S, M, L, XL.

For right hand shooters.

**Art.-Nr.: 125**

For left hand shooters.

**Art.-Nr.: 125-L**



Material: 60% leather und 40% artificial leather.  
 Inner lining: 34% wool, 33% viscose and 33% polyacryl.  
 Padding: India rubber.



### ahg-TRIGGER: ▶

5-finger glove.  
 A new glove developed by ahg-Anschütz especially for the trigger hand. The double fleece material ensures a comfortable and constant temperature of the hand. The forefinger is open for a direct contact to the trigger.  
 The special soft leather in the palm clings to the pistol grip of the gun and thus ensures a non-slide grip. If required, the glove can be washed at 30° C.

Sizes: XS, S, M, L, XL, XXL.

For right hand shooters.

**Art.-Nr.: 119**

For left hand shooters.

**Art.-Nr.: 119-L**

Material:  
 46% leather, 50% polaire polyester and 4% rubber.





# ahg-SHOOTING GLOVES

as individual as your personality

22



Material: 100% leather.  
Inner lining: 34% wool, 33% viscose and 33% polyacryl.  
Padding: Top Grip.

## ▲ ahg-COMFORT SHORT:

- 5-finger glove.
- Cross slot at the back for better bending.
- Firm leather material improves the stability.
- The fingers of the glove are open, thus allowing better regulation of temperature and enabling the loading of the rifle with the left hand (thumb and forefinger).
- Corresponding to the ISSF and DSB-rules.
- Pleasant contact feeling between stock and glove because of the Top-Grip-material.

Size: XS, S, M, L, XL.

For right hand shooters.

**Art.-Nr.: 116**

For left hand shooters.

**Art.-Nr.: 116-L**



Material: 60% leather and 40% artificial leather.  
Inner lining: 34% wool, 33% viscose und 33% polyacryl.  
Padding: India rubber.

## ▲ ahg-HIGH-TECH:

- 5-finger glove.
- Cross slot at the back for better bending.
- Firm leather material improves the stability.
- Corresponding to the ISSF + DSB-rules.

Size: XS, S, M, L, XL.

For right hand shooters only.

**Art.-Nr.: 129**



Material: 100% leather.  
Inner lining: 34% wool, 33% viscose and 33% polyacryl.  
Padding: Top Grip.

## ◀ ahg-TOP GRIP COLOR:

- 5-finger glove.
- Top-class glove of fine and supple leather, with stretch band.
- Optimized comfortable cut with maximum padding according to ISSF + DSB-rules.
- Overlaid with non-slip TOP GRIP material.
- Ventilation patterns on the side back of the hand guarantee best air circulation.

Sizes: XXS, XS, S, M, L, XL.

For right hand shooters.

**Art.-Nr.: 101C**

For left hand shooters.

**Art.-Nr.: 101C-L**

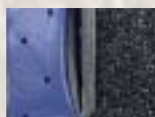



XXS = Extra, extra small  
 XS = Extra small  
 S = Small  
 M = Medium  
 L = Large  
 XL = Extra large  
 XXL = Extra extra large

Material: 100% leather.  
 Inner lining: 34% wool, 33%  
 viscose und 33% polyacryl.  
 Padding: Top Grip.



**Top price**

Material: 100% leather.  
 Inner lining: 34% wool, 33%  
 viscose und 33% polyacryl.  
 Padding: Top Grip.



Material: 60% leather  
 and 40% artificial leather.  
 Inner lining: 34% wool, 33%  
 viscose und 33% polyacryl.  
 Padding: India rubber.



23

**ahg-SUPER GRIP:**

**Top price**

5-finger glove.  
The inexpensive ahg beginner model. In the fashionable color combination: black-blue.

- Stretch band on wrist.
- Anti-slip padding.

Sizes: XS, S, M, L, XL.

For right hand shooters.

**Art.-Nr.: 111**

For left hand shooters.

**Art.-Nr.: 111-L**

**ahg-STANDARD 1:**

- 5-finger glove.
- TOP GRIP padding.
  - Stretch band on wrist.
  - According to ISSF + DSB-rules.
  - Color: black-blue.

Sizes: XS, S, M, L, XL.

For right hand shooters only.

**Art.-Nr.: 112**

**ahg-SHORT BLACK:**

- 5-finger glove.
- Cross slot at the back for better bending.
  - Firm leather material improves the stability.
  - The fingers of the glove are open, thus allowing better regulation of temperature and enabling the loading of the rifle with the left hand (thumb and forefinger)
  - According to ISSF + DSB-rules.

Sizes: XS, S, M, L, XL.

For right hand shooters only.

**Art.-Nr.: 115**

Material: 100% leather.  
 Inner lining: 34% wool, 33%  
 viscose und 33% polyacryl.  
 Padding: Top Grip.



**ahg-COLOR 1:**

**Top price**

- 5-finger glove.
- TOP GRIP padding.
  - Stretch material at the wrist.
  - According to ISSF + DSB-rules.
  - Color combination grey-yellow-black.

Sizes: XS, S, M, L, XL.

For right hand shooters only.

**Art.-Nr.: 109**

**ahg-SHORT:**

- 5-finger glove.
- Cross slot at the back for better bending.
  - Firm leather material improves the stability.
  - The fingers of the glove are open, thus allowing better regulation of temperature and enabling the loading of the rifle with the left hand (thumb and forefinger).
  - Corresponding to the ISSF + DSB-rules.
- Sizes: XS, S, M, L, XL.

For right hand shooters only.

**Art.-Nr.: 128**

Material: 60% leather and  
 40% artificial leather.  
 Inner lining: 34% wool, 33%  
 viscose und 33% polyacryl.  
 Padding: India rubber.



Material: 100% leather.  
 Inner lining: 34% wool, 33%  
 viscose und 33% polyacryl.  
 Padding: Top Grip.



**ahg-COLOR 2:**

- 5-finger glove.
- TOP GRIP padding.
  - Stretch material at the wrist.
  - According to ISSF + DSB-rules.
  - Color: red-blue.

Sizes: XS, S, M, L, XL.

For right hand shooters.

**Art.-Nr.: 110**

For left hand shooters.

**Art.-Nr.: 110-L**



# ahg-SHOOTING CAPS etc.

high quality shooting caps



24



## ▲ NEOPREN CAP:

- Protection from scattering light.
- Flexible and light, thus comfortable to wear.
- Corresponds to ISSF + DSB-rules.

Material:  
100% PU.

**Art.-Nr.: 301**



## ▲ ahg-Headband SPORTLINE:

- With sun shield.
- With velcro strap for individual adjustment of the sun shield.
- Highly suitable for changing light conditions at the shooting range.

Material:  
92% polyester, 8% rubber.

**Art.-Nr.: 326**



## ▲ ahg-HEADBAND WITH EYESHIELD:

- With non-reflective and scratch-resistant eye-flap.
- Corresponds to ISSF + DSB-rules.

Material:  
92% polyester und 8% rubber.

**Art.-Nr.: 324**

Like Art. 324 but with the colors black, red and blue on white.

**Art.-Nr.: 316**

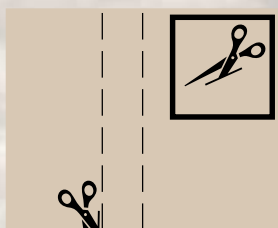

You can cut along the line.



The long badge on the ahg-shooting cap avoids negative effects of the disturbing light from above to the shooting process.

The integrated perspiration absorbing sweatband gives even more wearing comfort. The Velcro allows a snug fit to any head size. The side parts are made of a net material which allows air circulation and thus balances the temperature. The eye shield can be adjusted individually by Velcro. Simply flip the side flaps up and the cap corresponds to DSB and ISSF rules. If the shooter has to obey other rules which do allow side flaps, these can simply stay the way they are.

## ▲ ahg-SHOOTING CAP:

- Side flaps can be flipped up.
- The side parts are made of a net material which allows air circulation.

Material:  
60% cotton, 40% polyester.

Blue-black.

**Art.-Nr.: 325 Color**



320 Color



## ▲ ahg-SHOOTING CAP:

- Side flaps can be flipped up.
- Perspiration absorbing sweatband.
- Individually adjustable eyeshield.
- The side parts are made of a net material which allows air circulation.

Material:  
60% cotton, 40% polyester.

Red-beige.

**Art.-Nr.: 320**

Black-blue.

**Art.-Nr.: 320 Color**





25



Top price

▲ **ahg-HEADBAND WITH JOINT EYESHIELD:**

- With eyeshield.
- Corresponds to ISSF + DSB-rules.
- Flip-up eyeshield.
- Can be tilted to all sides by joint.

Material:  
92% polyester, 8% rubber.

Black, red and yellow on white.

**Art.-Nr.: 321**

Black, red and blue on white.

**Art.-Nr.: 315**

▲ **ahg-HEADBAND:**

Material:  
92% polyester, 8% rubber.

**Art.-Nr.: 323**

Top price



▲ **ahg-SHOOTING CAP:**

- ahg-cap without head part.
- Perspiration absorbing headband.
- Two side flaps.
- Adjustable eyeshield.

Material:  
60% cotton, 40% polyester.

**Art.-Nr.: 322**



▲ **ahg-SHOOTING CAP:**

- With removable side flaps.
- Side flaps with velcro closure.
- Individual adjustment of head size.

Material:  
60% cotton, 40% polyester.

**Art.-Nr.: 319**



# ahg-KNEELING ROLLS

stable and comfortable in kneeling position

## ahg-KNEELING ROLLS:

- Excelsior cork filler for comfortable support of ankle joint.
- No marks due to zippers in the front end.
- Robust hanger for easy use.
- High quality material.

26



## ahg-KNEELING ROLL TOP GRIP:

Without filler.

**Art.-Nr.: 372**

With filler.

**Art.-Nr.: 373**

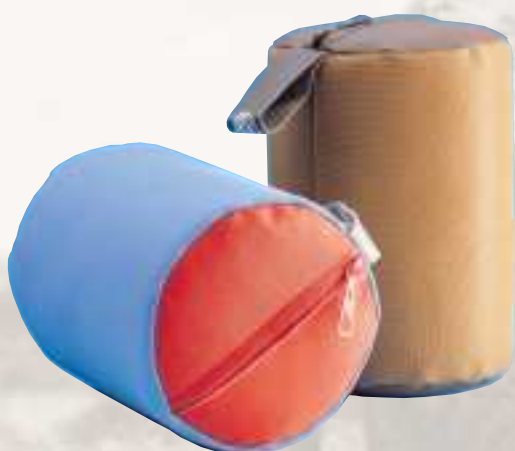

## ahg-KNEELING ROLL NON-SLIP:

**Art.-Nr.: 350** Brown, without filler.

**Art.-Nr.: 351** Brown, with filler.

**Art.-Nr.: 370** Blue-red without filler.

**Art.-Nr.: 371** Blue-red with filler.

## ahg-KNEELING ROLL COLOR from canvas:

**Art.-Nr.: 360 Color** Without filler black/blue.

**Art.-Nr.: 360** Without filler blue/red.

**Art.-Nr.: 361 Color** With filler black/blue.

**Art.-Nr.: 361** With filler blue/red.



## ahg-CORK FILLER:

For one kneeling roll.

**Art.-Nr.: 364**



## ahg-KNEELING ROLL SUEDE:

**Art.-Nr.: 380** Without filler.

**Art.-Nr.: 381** With filler.





# ahg-SHOOTING SLINGS

non-extending. Also available for left **L** hand shooters

## ahg-SHOOTING SLINGS:

Optimum connection of the sling to the shooter's jacket is ensured by a slewable metal clip on the ahg sling into which the hook (Art. 336) of the ahg-shooting jacket engages. In this manner slipping of the sling is prevented.

- Pliable, no-stretch material guarantees constant sling length.
- Optimum connection to the shooter's jacket.
- Freely mobile metal catch is hooked to the shooting jacket.
- No slipping of the sling.

## ahg-SHOOTING SLING ► CONSTANT:

Leather.

**Art.-Nr.: 333** **L**

Synth. material, black.

**Art.-Nr.: 335** **L**



## ahg-SHOOTING SLING ► PROFESSIONAL:

With additional advantages such as the well-known and approved swivel metal clip.

- Variable adjustment of the arm loop.
- For right and left hand shooters.
- Narrow distance of holes for exact adjustment.

**Art.-Nr.: 330** **L** Leather.

**Art.-Nr.: 331** **L** Synth. material, black.

**Art.-Nr.: 332 B** Synth. material, blue.



## ahg-SHOOTING SLING ► SWING:

ahg-shooting sling SWING is the latest development of ahg-Anschütz. This is a sling with combined precise adjustment.

This sling offers the following advantages:

- Easy adjustment of length with one hand while staying in position.
  - Automatic axial adaption of the forepart of the sling to guarantee a permanent optimum application of force in position.
  - Sling fixing and sling are connected by a special persenning closure with which it is possible to couple and uncouple the sling quickly with one hand.
  - The arm sling with 4 times adjustable reception for the persenning closure guarantees an optimum sling position.
- In addition the arm sling can be individually adapted to the upper arm by a buckle.

- Special, non-extendable sling material with textile inlay guarantees optimum stability.



## ▲ ahg-SHOOTING SLING CLIP:

The ahg-shooting sling model CLIP has a new fine adjustment which allows a quick and simple adjustment of length.

**Art.-Nr.: 337** **L**

**Art.-Nr.: 341** **L**





# ahg-Weapon Safety Accessories

Safety - Safety - Safety

28

## ahg-SAFETY LOOK: ▶

Safety first!  
 - Synthetic cartridge with signal flag.  
 - Give signal, there is no live cartridge in chamber.  
 - No cooling down of barrel.  
 - Available in cal. 4.5 mm-art.no. 1301  
 .22 mm-art.no. 1300



- |                       |  |                       |  |
|-----------------------|--|-----------------------|--|
| <b>Art.-Nr.: 1300</b> | Safety look for cal. .22 l.r.          | <b>Art.-Nr.: 1306</b> | Safety look for cal. 6 mm BR / .308 Win. / 30.06 |
| <b>Art.-Nr.: 1301</b> | Safety look for air rifle and pistol.  | <b>Art.-Nr.: 1307</b> | Safety look for cal. 6,5 x 5,5                   |
| <b>Art.-Nr.: 1302</b> | Safety look for cal. .32               | <b>Art.-Nr.: 1308</b> | Safety look for cal. 8 x 57                      |
| <b>Art.-Nr.: 1303</b> | Safety look for cal. .38 / 9 mm / .357 | <b>Art.-Nr.: 1309</b> | Safety look for cal. 7,5 x 55                    |
| <b>Art.-Nr.: 1304</b> | Safety look for cal. .44               | <b>Art.-Nr.: 1310</b> | Safety look for Schrot cal. 12                   |
| <b>Art.-Nr.: 1305</b> | Safety look for cal. .45               | <b>Art.-Nr.: 1311</b> | Safety look for cal. 9 mm / para                 |

## ahg-SAFETY LOOK FOR TRIGGERS: ▶

Protects your rifle from unauthorized use.  
 Suitable for all rifles.  
**Caution:**  
 Install only to an unloaded rifle.  
 Store your rifle in unloaded condition!

**Art.-Nr.: 711.7250**



## ahg-SAFETY ROD SIGNAL LINE: ▶

Recently, security regulations for shooting ranges have been enforced and now require that non-loaded barrels have to be marked.

pushed to the muzzle, then the end of the safety cord is pulled out of the muzzle. This is a clear sign that the sporting gun is not loaded.

Therefore, we have immediately developed the safety cord "signal line" usable for all calibres.

The safety cord is supplied in units of 1 m or 10 m for individual cutting.

**Art.-Nr.: 1400** 1 m.

**Art.-Nr.: 1401** 10 m.





# ahg-MUFFLERS

to keep things quiet



## ▲ ahg-ELECTRONIC MUFFLERS:

Optimum protection. Automatic sound insulation is actuated at props.

- Speech permeability.
- No hindrance while shooting.
- Extraordinary insulating properties.
- Variably adjustable.
- Folding ear cups with electronic device, insulation at over 83dB (shots etc.), for one battery.

**Art.-Nr.: 307**



## ▲ PELTOR-POCKET MUFFLERS:

The slim design of these hearing protectors makes them especially suitable for target shooters.

- Very light (approx. 180 g).
- Comfortable fit.
- Obstruction-free when positioning.
- Considerable sound insulation.
- Variably adjustable.

**Art.-Nr.: 313**



## ▲ ahg-POCKET MUFFLERS:

A special ahg product developed for the shooter with regard to sound dissipation.

- Very light (approx. 180 g).
- Foldable.
- Wide soft folding ear cups.
- Adjustable spring steel head band.
- Noise reduction rating 17 decibels.

**Art.-Nr.: 308**



## ◀ ahg-EAR PROTECTOR JELLY PLUG:

These jelly plugs will eliminate the shooting noise and enable better concentration on your competition.

They can be washed, they are connected with a cord for your neck and are supplied with a small box for storage.

**Art.-Nr.: 306**



## ▲ ahg-SPORTS GLASSES:

Stable sportsglasses protect your eyes and increase the contrast of the environment.

**Art.-Nr.: 1013** Grey.

**Art.-Nr.: 1014** Yellow.



## ▲ ahg-EAR PLUG CEASE FIRE:

This ear plug muffles every loud noise with a baffle inside the plug cartridge. At low levels of noise, the valve is open. Loud or impact noises cause the baffle to close, providing hearing protection. The ear plug can be washed and is supplied with a plastic box for safe storage.

**Art.-Nr.: 305**

# ahg-AMMUNITION BOX

a maximum of order for your ammunition.

The ammunition box SB-200 has been developed for easy handling of the ammunition. Especially suited for low temperatures when the fingers tend to stiffen. For 100 pc. of ammunition and 2 boxes in the middle.

Outer dimension:  
22 x 11 x 5 cm.

**Art.-Nr.: 269**



29



# ahg-GUN CASE

safe from A to B

## ahg-TRANSPORT CASES:

- Case construction deep molded, high impact, luggage-grade material designed to withstand severe handling.
- Interior padding for complete firearm protection with fully convoluted interlocking padding.
- Continuous hinge piano type for rugged long lasting strength and tamper-proof protection.
- Aluminium frame to provide maximum strength and durability with four heavy

- clasps, two of which may be locked by key.
- Twin carrying handles molded for strength and comfort, assure case support and maximum carrying ease.
- Support pads designed as part of the molded case, protect against damage and provide a stand-alone feature.
- Meets the security regulations of the FAA applicable for the transport of firearms as luggage on commercial airlines.

30

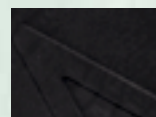
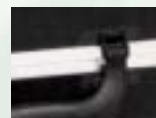

233



202



201



203



Outer dimension:

<b>Art.-Nr.: 233</b>	For break-down guns	96,5 x 32 x 11,5 cm	3,50 kg
<b>Art.-Nr.: 202</b>	For two rifles	133,5 x 32 x 11,5 cm	4,60 kg
<b>Art.-Nr.: 201</b>	For one rifle	122,5 x 25,5 x 11,5 cm	3,25 kg
<b>Art.-Nr.: 203</b>	For two rifles, extra wide	133,5 x 37 x 11,5 cm	4,90 kg





All case dimensions are outer dimensions.

**ahg-GUN CASE FOR 1 RIFLE:**

The design of this light-weight and inexpensive case is made for safe storage of one rifle with sights. The case has four press-stud closures and integrated holes for a lock.

Outer dimension:  
133,5 x 29 x 8 cm.  
Weight:  
1,8 kg.

**Art.-Nr.: 250**



**ahg-TRANSPORT CASE FOR 2 RIFLES:**

This light and low-priced case is designed for two rifles. It has press-stud closures for safe locking and integrated holes for fasteners.

Outer dimension:  
132,5 x 40,5 x 10 cm, 3,9 kg.

**Art.-Nr.: 255**

**ahg-HARD SHELL GUN CASE:**

- Light and handy model.
- Convolutated foam padding for special protection of your gun.
- Injection molded, strong polypropylene material.
- High strength polypropylene hinges.
- Sliding positive latches.
- Deep diamond checkering.
- Deep molded valences.



256



249



248

Outer dimension:

<b>Art.-Nr.: 256</b>	122 x 28 x 8,5 cm	2,30 kg
<b>Art.-Nr.: 249</b>	42 x 37 x 15 cm	1,40 kg
<b>Art.-Nr.: 248</b>	34,5 x 26 x 7,5 cm	0,50 kg



# ahg-TRANSPORT CASES

unsurpassed in function



32



## ahg-WATERPROOF for rifles:

Especially for the transportation of rifles in airplanes

- Extra strong.
- Waterproof and air-tight (o-ring).
- With pressure release valve.
- Wide design.
- Perfect protection of your rifle.
- Optimum transportation in airplanes.
- With rollers for easy transport.

Outer dimension:  
137 x 39 x 15 cm 7,1 kg.

**Art.-Nr.: 285**



## ahg-RIFLE CASE:

- For one or two rifles.
- Additional space for accessories.
- Maximum safety.
- Very suitable for air rifles.

Outer dimension:  
121 x 39 x 13 cm 4,7 kg.

**Art.-Nr.: 253**



## ahg-WATERPROOF for pistols:

- Same features as Art. 285, but other dimensions.

Outer dimension:  
53 x 42 x 23,5 cm, 4,5 kg.

**Art.-Nr.: 287**



## ahg-HUNTING CASE:

- For scoped hunting rifle.
- Air rifles.

Outer dimension:  
135 x 28,5 x 11 cm, 2,1 kg.

**Art.-Nr.: 261**





# ahg-SOFT CASE PICK-UP

soft protection with a lot of space

## ahg-PICK-UP SOFT CASE:

In permanent contact and cooperation with top-class shooters ahg-Anschütz Handelsgesellschaft has developed the new soft case "PICK-UP".

The new soft case "PICK-UP" is equipped with a new zipper system and other useful details.

For safe transportation of the target rifle as well as the sensitive accessories. It is also possible to carry the soft case on the back due to a special belt system.

In addition you can use the soft case as a pad on which you can assemble your rifle.

- Inner lining of anti-static material to avoid dirt on the rifles.
- Fixing belts with velcro closure hold the rifle in a safe position.
- The cut follows the shape of the rifle to avoid any slipping in the soft case.
- Extra departments to store tools and accessories.
- Integrated holder for a spare compressed air cylinder.
- Carrying handle.
- Carrying belt system to carry the soft case on the back or to transport it on a bicycle.
- Hanger to hang it on a hook.

**Art.-Nr.: 9209** Black.

**Art.-Nr.: 9209-b** Blue.



33

# ahg-SOFT CASES FOR GUNS

soft protection

## ahg-SOFT GUN CASE: ▶

- Rivetted carrying slings.
- Bag for your name plate.
- Special bag with zipper for accessories.
- Lockable by key.
- Attractive colors.

**Art.-Nr.: 9204**

**Art.-Nr.: 9205**

**Art.-Nr.: 9207**



9204

9205

9200 TR

9207

## ahg-STRAPS:

- For soft gun case.
- Adjustable in length.

**Art.-Nr.: 9200 TR**



## ◀ ahg-SOFT GUN CASE:

- 2 bags with zipper.
- Attractive colors.

**Art.-Nr.: 9203**

## ◀ ahg-SOFT CASE FOR RIFLES:

- Simple and top price soft case for the transportation of rifles incl. lateral bag.

**Art.-Nr.: 9202**



## ▲ ahg-SPECIAL SOFT GUN CASE:

- Extra PVC-foil between foam and inner lining for special protection.
- Inner lining of polyester prevents fluffs on the lining and thus protects trigger and barrel action from dirt.
- Easy care with vacuum cleaner or damp cloth.
- Extra wide and strong shoulder straps.
- Straps for one compressed air cylinder.

**Art.-Nr.: 9201**



## ▲ ahg-PISTOL SOFT CASE:

- Protects the pistol against environmental influences.
- 9208 is equipped with a 5 cm foam layer to protect the pistol against scratches and impacts.
- Top price.

**Art.-Nr.: 9208**



# ahg-CLEANING ACCESSORIES

cleaning products for your shooting equipment



35



## ▲ ahg-CLEANING PATCH:

- Refill pack for Art.-Nr. 504 and 507.  
 - 50 cleaning patches.  
 - For optimum gun care.  
 - Absorbant and free of fluffs.

**Art.-Nr.: 506**



## ▲ ahg-CLEANING TUBE:

- To clean rifles and pistols.  
 - Cleaning tube (86 cm) with rubber coating for cleaning pads and brushes.  
 - For cal. 4.5 mm and .22 l.r.  
 - Incl. brushes for cal. 4.5 and .22 l.r.

**Art.-Nr.: 505**



## ▲ ahg-CLEANING KIT:

- The cotton wicks are pressed into the barrel and remove all residues of gun powder and dirt.  
 - The bolt remains on the rifle.  
 - For rifles and pistols.  
 - Untearable until 60 kg.  
 - For all calibers including air rifle.  
 - A light-weight set for easy and thorough cleaning simply by pulling.  
 - Ready for use, no assembly required.

**Art.-Nr.: 507**



## ▲ ahg-CLEANING BOX:

- For air rifles and small bore rifles.  
 With:  
 - Cleaning oil.  
 - Cleaning brushes.  
 - 2 Cleaning cord with thread (86 + 41 cm).  
 - Screw-on grip.  
 - 10 cleaning patches.

**Art.-Nr.: 504**



## ▲ ahg-COTTON WICKS:

- Refill pack for Art.-Nr. 507.  
 - 32 cotton wicks for rifles and pistols.

**Art.-Nr.: 508**



## ▲ ahg-GUN SIGHT DARKENER BLACK MATCH:

- For perfect blackening of front sight, rear sight and barrel.  
 - To be used like a lighter to darken the desired parts.

**Art.-Nr.: 523**

## VFG-FELT PELLETS:

- Complete cleaning program for your rifle or pistol.

- 1** VFG-FELT CLEANERS for guns cal. .22 l.r.:  
 - Contents: 80 pcs.

**Art.-Nr.: 519**

- 2** VFG-FELT CLEANERS for guns cal. .22 l.r.:  
 - Contents: 500 pcs.

**Art.-Nr.: 520**

- 3** VFG-SUPERINTENSIVE FELT PELLETS cal. .22 l.r.:  
 - Contents: 80 pcs.

**Art.-Nr.: 521**

- 4** VFG-CLEANING ROD in one piece cal. .22 l.r. - 6,5 mm.

**Art.-Nr.: 530**

- 5** VFG-TUBE for BARREL MANTLE and CENTRE CASE.

**Art.-Nr.: 532**

- 6** VFG-ADAPTER for cleaning rod 530.

**Art.-Nr.: 531**

- 7** VFG-FELT PELLETS for air rifle and air pistol. - Cal. 4,5 mm, 100 pcs.

**Art.-Nr.: 514**

- 8** VFG-SUPERINTENSIVE RIFLE CLEANER - Cal. 4 - 4,5 mm, 100 pcs.

**Art.-Nr.: 513**

- 9** VFG-SUPERINTENSIVE RIFLE CLEANER - Cal. .58, 25 pcs.  
 - Special felt with brass fibres.

**Art.-Nr.: 534**



- 10** VFG-FELT PELLETS FOR AIR RIFLES - Cal. 4,5 mm - 500 pcs.

**Art.-Nr.: 515**

- 11** VFG-RIFLE CLEANER - Cal. 4 - 4,5 mm - 100 pcs.

**Art.-Nr.: 516**

- 12** VFG-BASIC CLEANING EQUIPMENT: - Set for air rifle and air pistol. - Cal. 4,5 mm.

**Art.-Nr.: 512**

- 13** VFG-BARREL CLEANING PASTE - Polish and conservation.

**Art.-Nr.: 511**

- 14** VFG-LUPUS Teflon Grease.

**Art.-Nr.: 510**

- 15** VFG-FELT PAD Protection for gun and table. - Measurements: 30 x 100 cm.

**Art.-Nr.: 529**





# ahg-TRIPODS

solid helpers

36

## ahg-UNIVERSAL TRIPOD ▶ with Swivel Joint:

The ahg-universal tripod has a new center column that allows easy changing in every shooting position. The excenter nut continuously fastens the modules of the telescope bar. This tripod can be demounted easily.

The standing legs can be screwed into the basic-ball body in 2 different angles. The tripod thus adjusts to the individual circumstances on the shooting range.

The high-tech clamping mechanism in the aluminum head can compensate high forces. The special coated surface completes this product's stability and handiness. This ahg-universal tripod can be adjusted individually up to a height of 170 cm on the telescope.

The design of ahg-universal tripod allows accessories like the ahg-ammunition holder or the ahg-rifle holder to be mounted additionally.

Total weight: 1100 g.

**Art.-Nr.: 451**

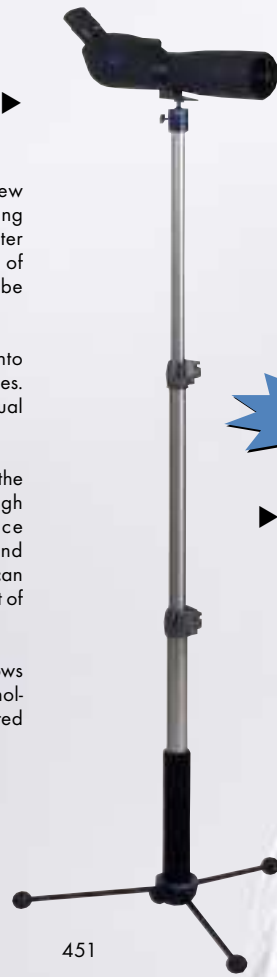

451

NEW!



451

NEW!



457

## ahg-RIFLE HOLDER TRIPOD „de luxe“:

The ahg-rifle holder tripod has all the advantages of the universal tripod with ammunition and rifle holder but without the swivel joint and the prone adapter screw.

**Art.-Nr.: 457**

## ahg-LOADING PAD: ▶

A competition shooting special: anti-gliss pad mounted on a rock-solid tripod. Shooters rest the rifle on the pad to ensure that shoulder set and cant angle remain steady while loading.

- Solid tripod.
- Anti-slip surface.
- Variably adjustable.
- Cartridge holder for air and small bore rifle ammunition.

**Art.-Nr.: 453**

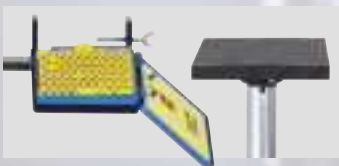

NEW!



## ahg-SWIVEL JOINT: ◀

The technically lavish clamping mechanism inside the aluminum head is very durable. Especially layered surfaces complete the characteristics like stability and handiness. The swivel head has a connecting joint of 1/4" and 3/8".

**Art.-Nr.: 450**



## ahg-PRONE TRIPOD: ◀

- Prone position tripod.
- Steady tripod.
- Anti-glide leg tips.
- Easy fold-away.
- Lightweight (275 g).
- Swivel joint inclusive.

**Art.-Nr.: 454**





# ahg-SPOTTING SCOPES

for high quality spotting



37



▲  
**ahg-SOFT CASE**  
for SPOTTING SCOPE:

- For all ahg-spotting scopes.
- With carrying sling.
- With velcro closure.

**Art.-Nr.: 400**



▲  
**ahg-SPOTTING SCOPE**  
15-45 x 65:

- High quality spotting scope with 45° interchangeable eye piece.
- Rotating bracket for optimal angular adjustment of the scope.
- Water rejecting surface.
- Including camera adaptor.
- For all shooting positions until 100 m.

**Art.-Nr.: 444**



▲  
**ahg-SPOTTING SCOPE**  
20 x 50:

- High quality spotting scope with water rejecting surface and low weight (300 g).
- Excellent for all pistol shooters.
- Compact construction, 19 cm long, fits into every bag.
- With carrying bag.

**Art.-Nr.: 443**



▲  
**Hunting Binoculars**  
MONARCH:

- Overwhelming robustness and performance for the ambitious hunter.
- All lenses and prisms are multilayer coated.
- Phase correction coated roof prisms for high resolution.
- High-reflection mirror-coating prisms for bright image.
- High-eye point design provides a clear field of view, even for eyeglass wearers.
- Close focusing distance: 2.5 m.
- Waterproof (up to 2 m for 5 min) and fog-free with O-ring seals and nitrogen gas.
- Eco-glass optics free of lead and arsenic.
- Rubber armoring for shock resistance.
- Turn-and-slide rubber eyecup.
- 8 x 42.

**Art.-Nr.: BAA610AA**



▲  
**Telescopic Sight**  
MONARCH II:

For especially demanding hunters. These models have a tube diameter of 25.4 mm as well as flat adjustment towers which allow a quick and precise fine-tuning by hand.

- 3,5-10 X 50.
- Black matte.
- Illuminate Mildot.

**Art.-Nr.: BRA10907**

- 5,5-16,5 x 44 AO.
- Black matte.
- Duplex.

**Art.-Nr.: BRA10301**

- 6,5-20 x 44 AO.
- Black matte.
- Duplex.

**Art.-Nr.: BRA12200**

- 6,5-20 X 44 AO.
- Black matte.
- Mildot.

**Art.-Nr.: BRA122AA**

- Monarch E:
- 2,5-10 X 56.
  - Black matte.
  - 30 mm tube diameter.
  - Illuminate Mildot.

**Art.-Nr.: BRA11902**



▲  
**Rangefinder LASER 600:**

Accurate measuring promises more hunting success.

- 10-99,5 m: Every 0,5 m.
- 100-546 m: Every 1 m.

**Art.-Nr.: BKA020AH**



▲  
**Spotting Scope**  
RA II A:

- Without eyepiece.
- Lightweight and compact.
- Water resistant due to O-ring seals.
- Very high translucency.
- Built-in type slide hood.
- Objective diameter 60 mm.

**Art.-Nr.: BDAO14AE**

**Eyepiece for RA II A:**

- 20 x eyepiece.

**Art.-Nr.: BDB90020**

**Eyepiece for RA II A:**

- Variable 15-45 x.

**Art.-Nr.: BDB90039**



Nikon – maximum quality!  
Everything started in 1917  
with binoculars. Today, Nikon  
manufactures binoculars,  
spectacles, telescopic sights,  
distance measuring devices,  
night vision goggles and  
cameras.

ahg provides  
the complete  
Nikon sports  
optics supply!





# ahg-IRIS FRONT SIGHT







38

## ahg-DUO-IRIS FRONT SIGHT:





Inner and outer diameter step-lessly adjustable to meet varying light conditions and target sizes.

- The extraordinarily wide adjustment range makes the Duo Iris Front Sight a perfect choice for all shooting disciplines.
- Available with cross hair ring (9750, 9751, 9752, 9752F), with the option to switch to lateral hair for air gun competitions.
- Also available as glass ring version (9760, 9761, 9762, 9762F).



ANSCHÜTZ Systems / Ø	M18	M22	Type
2.8 - 4.8 inside / 6.4 - 9.0 outside	<b>Art.-Nr.: 9750</b>	<b>Art.-Nr.: 9752</b>	 
3.8 - 5.8 inside / 7.6 - 10.2 outside	<b>Art.-Nr.: 9751</b>	<b>Art.-Nr.: 9766</b>	 
2.8 - 4.8 inside / 6.4 - 9.0 outside	<b>Art.-Nr.: 9760</b>	<b>Art.-Nr.: 9762</b>	
3.8 - 5.8 inside / 7.6 - 10.2 outside	<b>Art.-Nr.: 9761</b>	<b>Art.-Nr.: 9764</b>	







FEINWERKBAU Systems / Ø	M18	M22	Type
2.8 - 4.8 inside / 6.4 - 9.0 outside	<b>Art.-Nr.: 9750 F</b>	<b>Art.-Nr.: 9752 F</b>	 
3.8 - 5.8 inside / 7.6 - 10.2 outside	<b>Art.-Nr.: 9751 F</b>	<b>Art.-Nr.: 9766 F</b>	 
2.8 - 4.8 inside / 6.4 - 9.0 outside	<b>Art.-Nr.: 9760 F</b>	<b>Art.-Nr.: 9762 F</b>	
3.8 - 5.8 inside / 7.6 - 10.2 outside	<b>Art.-Nr.: 9761 F</b>		

## ahg-SUPER-IRIS FRONT SIGHT:

- Adapts easily to varying light conditions and target sizes due to 2.8 - 4.8 mm diameter range. Fixed ring width.
- To meet individual preferences the shooter may set either cross hair or lateral bar; special tool included.
- Optionally a larger front ring may be used to achieve better target coverage.
- M18 x 0.5 thread, fits Anschütz, Diana, Walther and Feinwerbau 601.

### ahg-SUPER-IRIS FRONT SIGHT:

Ø	M18 x 0,5	Type
2.8 - 4.8	<b>Art.-Nr.: 9740</b>	 
2.3 - 4.3	<b>Art.-Nr.: 9742</b>	 
3.8 - 5.8	<b>Art.-Nr.: 9743</b>	

### ahg-SUPER-IRIS GLASS FRONT SIGHT:

Ø	M18 x 0,5	M22 x 0,5	Type
1.8 - 4.3	<b>Art.-Nr.: 9733</b>	<b>Art.-Nr.: 9749</b>	
2.8 - 4.8	<b>Art.-Nr.: 9744</b>	<b>Art.-Nr.: 9747</b>	
2.3 - 4.3	<b>Art.-Nr.: 9745</b>		
3.8 - 5.8	<b>Art.-Nr.: 9746</b>	<b>Art.-Nr.: 9748</b>	

### ahg-SUPER-IRIS GLASS FRONT SIGHT SQUARE:

Ø	M18 x 0,5	M22 x 0,5	Type
2.8 - 4.8	<b>Art.-Nr.: 9605</b>	<b>Art.-Nr.: 9607</b>	
3.8 - 5.8	<b>Art.-Nr.: 9606</b>	<b>Art.-Nr.: 9608</b>	



## ahg-SUPER-IRIS GLASS FRONT SIGHT:

- Just like front sight 9740 this Super-Iris-Glass Front Sight features an extremely wide adjustment range, based on the double-pronged aperture design.
- Easy fitting of sight into the front tunnel.
- Stepless adjustment.

## ahg-GLASS APERTURE SQUARE:

- Adjustable aperture with a polished glass carrier and a squared external contour. Ideal for bench rest shooters.





## ahg-VARIO SWING FRONT SIGHT:

The first aperture worldwide that allows canting at any time without any tool and within a few seconds.

The sight is screwed into the front tunnel and secured with a lock nut. To correct for canting simply adjust the scale on the housing. Several scale values may be marked and thus quickly recovered after a change of positions.

With a tool you can change the VARIO SWING FRONT SIGHT from lateral- to cross hair like art. 9740.

## ahg-APERTURE VARIO SQUARE:

Based on the Vario-Swing we have developed a square with an external contour that can be adjusted to the individual tilted angle without tools.



### ahg-VARIO SWING FRONT SIGHT:

Ø	M18 x 0,5	M22 x 0,5	Type
1.8 - 4.3	<b>Art.-Nr.: 9735</b>		
2.5 - 5.0	<b>Art.-Nr.: 9736</b>	<b>Art.-Nr.: 9738</b>	
3.3 - 5.8	<b>Art.-Nr.: 9737</b>	<b>Art.-Nr.: 9739</b>	
5.0 - 7.5		<b>Art.-Nr.: 9801</b>	



### ahg-VARIO SWING FRONT SIGHT SQUARE:

Ø	M18 x 0,5	M22 x 0,5	Type
2.5 - 5.0	<b>Art.-Nr.: 9601</b>	<b>Art.-Nr.: 9603</b>	
3.3 - 5.8	<b>Art.-Nr.: 9602</b>		
5.0 - 7.5		<b>Art.-Nr.: 9604</b>	



## ahg-IRIS FRONT SIGHT WITH LATERAL HAIR:

- For optimum adjustment to light conditions and target size.
- With the help of a locknut the aperture can be attached in a way to compensate any canting.

### ahg-IRIS FRONT SIGHT with lateral hair:

Ø	M18 x 0,5	M22 x 0,5	Type
2.5 - 5.0	<b>Art.-Nr.: 9520</b>	<b>Art.-Nr.: 9526</b>	
1.8 - 4.3		<b>Art.-Nr.: 9523</b>	
3.3 - 5.8	<b>Art.-Nr.: 9522</b>	<b>Art.-Nr.: 9527</b>	
2.5 - 5.0		<b>Art.-Nr.: 9526</b>	
1.8 - 4.3	<b>Art.-Nr.: 9524</b>		



## ahg-GLASS FRONT SIGHT HIGH END:

The sight ring is embedded in a ground-glass pane, thus completely distortion-free.

A strong contrast is created with the combination of glass and mat-black aperture. The use of glass and metal materials avoids variations in temperature, thus this front sight is especially suitable for big bore rifles.

- Optically perfect mat-black metal aperture set into a securely fixed glass holder.
- Distortion-free.
- Reflection-free front sight insert.
- Optimal contrast.
- Heat-resistant material.
- Easy substitution of front sight.
- Ideally suited for large-bore rifles.
- Easily adjustable to meet individual requirements.

For M18 x 0,5.

**Art.-Nr.: 9507**

For M22 x 0,5.

**Art.-Nr.: 9508**

Available diameters:  
Ø 3.0 - 5.0 in 0.1 mm steps  
with an aperture width of 1.2 mm.



## ahg-HIGH END SQUARE:

A product especially developed for Benchrest shooters. For older shooters it is sometimes a problem that the vision of the individual insert of a front sight becomes blurred or that they cannot see the complete 360° circle.

A square with a hole seems to be the only alternative to the common front sight that makes sense. Thus the round mirror is still centered with a round hole. Horizontal and vertical cants of the square may be used as a check against canting.

**Art.-Nr.: 9511** M18.

**Art.-Nr.: 9512** M22.

Available diameters:  
3.0 - 5.0 in steps of 0.1 mm.



# ahg-IRIS FRONT SIGHT



40

## ahg-FRONT SIGHT SWING:

This new front sight can be turned around its axle without any tools.

- Crimped clamp-ring for cross-level adjustment.
- Easy removal of the cross levels.
- Markers on the canting scale allow quick and precise recovery of settings for different shooting positions.

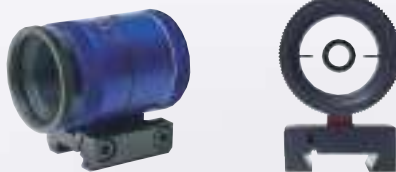

- Absolutely symmetrical build ensures clean target image.
- Further enhanced by a stub between tunnel and dovetail, which may be used for additional canting control.

SWING	M18	M22
ANSCHÜTZ	<b>Art.-Nr.: 9755</b>	<b>Art.-Nr.: 9756</b>
FEINWERKBAU	<b>Art.-Nr.: 9755 F</b>	<b>Art.-Nr.: 9756 F</b>

## ahg-FRONT SIGHT SWING PLUS:

Like ahg-front sight SWING but with integrated elevation.

- Elevation 8 mm.



SWING PLUS	M18	M22
ANSCHÜTZ	<b>Art.-Nr.: 9753</b>	<b>Art.-Nr.: 9757</b>
FEINWERKBAU	<b>Art.-Nr.: 9753 F</b>	<b>Art.-Nr.: 9757 F</b>

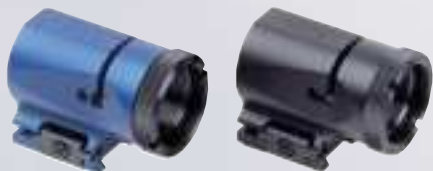

## ahg-FRONT SIGHT STRONG:

The new ahg-front sight STRONG has the following characteristics:

- Milled from full material, therefore especially strong.
- Special lateral clearing for easy handling of the steel aperture, at the same time the size of the aperture is visible (front sight for M 22 has no lateral clearing).
- New sturdy clamping device, especially suitable for 300 m, long range and crossbow.
- Suitable for models 1407 - 1813 (replacement for ANSCHÜTZ front sight Art. 6523).

Black.

**Art.-Nr.: 9759**

Blue.

**Art.-Nr.: 9759-b**

Black.

**Art.-Nr.: 9763**



## ahg-PLASTIC FRONT SIGHT INSERT SET:

One set with diameters: 3,2 / 3,4 / 3,5 / 3,6 / 3,8 / 4,0 / 4,2 / 4,4. Suitable for target rifles: Anschütz, FWB, Walter, Diana und Steyr. For threads M18.

**Art.-Nr.: 9720-U8** Crystal clear.

**Art.-Nr.: 9721-U8** Yellow.

**Art.-Nr.: 9722-U8** Grey.

**Art.-Nr.: 9723-U8** Red.



## ahg-DUST PROTECTION CAP:

For front sight M18.

**Art.-Nr.: 9722-2**

For front sight M22.

**Art.-Nr.: 9722-3**







▲ **ahg-SPECIAL-FRONT SIGHT INSERT SET:**

One set with diameters:  
 Ø 3,3/3,5-3,9/4,1/4,3/4,5 = 9 St.  
 - Bans scattered light effects.  
 - Dazzling and reflection free.  
 - Rich in contrast.  
 - Optimum focus.  
 - Constant ring size.

- Art.-Nr.: 9724-U8** Yellow.
  - Art.-Nr.: 9725-U8** Red.
  - Art.-Nr.: 9726-U8** Blue.
  - Art.-Nr.: 9727-U8** Crystal clear.
- For FWB 602/603 M22.
- Art.-Nr.: 9727F-U8** Crystal clear.



▲ **ahg-SPECIAL PLASTIC APERTURES:**

From 2,8 to 5,5 mm. Steps:  
 - 2,8 - 4,1 in 0,1 mm.  
 - 4,3 - 5,9 in 0,2 mm.

- Art.-Nr.: 9724** Yellow.
  - Art.-Nr.: 9725** Red.
  - Art.-Nr.: 9726** Blue.
  - Art.-Nr.: 9727** Crystal clear.
- For FWB 602/603 M22.
- Art.-Nr.: 9726F** Blue.
  - Art.-Nr.: 9727F** Crystal clear.



▲ **ahg-OPTICAL LENS:**

For FWB 602, 603, P70, 0,3 diopter.

**Art.-Nr.: 9505-03**

▲ **ahg-OPTICAL LENS:**

For FWB 602, 603, P70, 0,5 diopter.

**Art.-Nr.: 9505-05**

▲ **ahg-CLAMPING RING for plastic aperture:**

For 9720 to 9727.  
 For threads M18 x 0,5.

**Art.-Nr.: 9722-1**

For threads M22 x 0,5.

**Art.-Nr.: 9722-4**

▲ **ahg-PLASTIC APERTURES:**

From 2,8 to 4,8 mm.

**Art.-Nr.: 9720** Crystal clear.

**Art.-Nr.: 9721** Yellow.

**Art.-Nr.: 9722** Grey.

**Art.-Nr.: 9723** Red.

For FWB 602, 603, P70 M22.

**Art.-Nr.: 9720 F** Crystal clear.

▲ **ahg-TRIANGLE APERTURES:**

Three spot adjustment of the mirror for less fatigue of the eye.

This is a good aiming aid, especially for those shooters who cannot focus 100% all 360°.

- No fatigue and reflection.
- For front sight thread M18:  
 Ø 2,8 - 4,1 mm in 0,1 mm and  
 Ø 4,3 - 4,7 mm in 0,2 mm increasing.
- For front sight thread M22:  
 Ø 2,8 - 4,1 mm in 0,1 mm and  
 Ø 4,3 - 5,5 mm in 0,2 mm increasing.

**Art.-Nr.: 9729** Yellow.

**Art.-Nr.: 9730** Red.

**Art.-Nr.: 9731** Blue.

**Art.-Nr.: 9732** Crystal clear.

For FWB 602/603 M22.

**Art.-Nr.: 9729F** Yellow.

**Art.-Nr.: 9730F** Red.

**Art.-Nr.: 9731F** Blue.

**Art.-Nr.: 9732F** Crystal clear.





# ahg-ACCESSORIES for PEEPSIGHT

because details decide your success

42

Top price



▲ STRASSER-EYE SHIELD BIG:

**Art.-Nr.: 9500** Black.

**Art.-Nr.: 9501** White.

To relax the aiming eye. This shield can be used for right or left hand shooters.



▲ STRASSER-EYE SHIELD SMALL:

The ahg-eye shield is simply being attached to the existing iris or sight disc. Strasser small corresponds to the latest DSB and ISSF rules.

**Art.-Nr.: 9499** Transparent.

**Art.-Nr.: 9498** White.

NEW!

NEW!



▲ ahg-COVERING DISCS for PLASTIC SHIELDS:

These ahg-covering discs are simply being attached to the existing rubber eyeshade (ahg 9700 or JGA 6700-20) which have a diameter of 27 mm. These 2 plastic discs (black and transparent) can be swung out individually to cover the non-aiming eye.

**Art.-Nr.: 9496**



▲ ahg-EYESHADE incl. 2 Discs to Cover the Non-Aiming Eye:

The ahg-universal eyeshade is simply attached to the existing iris disc or rear sight disc. Two plastic discs, transparent and black, (supplied) can be swung out in order to cover the non-aiming eye. This relaxes the aiming eye. This shield can be used by left or right hand shooters.

**Art.-Nr.: 9497**

NEW!



▲ ahg-EYE SHIELD:

For iris.  
- Made of Sikolex or Lexan.  
- To be attached to the rear iris to cover the non-aiming eye.

**Art.-Nr.: 9776-1** White.

**Art.-Nr.: 9776-2** Transparent.

ahg-Rear Sight SIGHT BASE „10-50“:

Rear sight for 10, 50 and 100 metres. Polished fine treaded spindles made from stainless steel, equipped with ball bearings guarantee absolute precision. This SIGHT BASE gives the shooter the advantage to still observe the environment e. g. wind condition. The shooter still has an overall view while taking aim. When shooting outdoors it allows also a better observation of the weather.

1 click on 10 m corresponds to 0,25 mm, 1 click on 50 m to 1,22 mm.

This sight base has a total weight of 200 g.

**Art.-Nr.: 9805**

NEW!





# ahg-IRIS DISCS

for comfortable sighting

## ahg-IRIS DISCS:

The main feature is an interchangeable color ring. The available colors were developed in close co-operation with opticians to prevent the eye from quick fatigue during competitions. According to the light conditions the contrast at the eye can be adapted by changing the aperture.

The design of the iris is a further advantage. It is based on more than 30 years of experience in the field of lamella construction. The shape of the lamella was optimized by computer simulation.

Modern production techniques made it possible to increase the number of lamellas to the incredible amount of **15 individual segments**. Only with this feature an absolutely round iris can be obtained which is of utmost importance for the shooter. The iris can now be adjusted from **0.5 to 3.0 mm**. This adjustment can easily be carried out during shooting by a simple linear movement of the lamellas.

### Reflexion

If beams of light coming from the air meet glass or if they come from glass and meet the air beams are reflected which do not reach the eye anymore and thus deteriorate the target picture.

For this reason ahg products are equipped with surfaces reduced in their reflecting capacity.

With ahg polarisation filter.



Without ahg polarisation filter.



ahg-iris with color filter Art.-No.: 9779 consists of the new contrast increasing color filter C 41 blue.

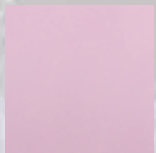

## ahg-IRIS DISC TWIN with 10 filters:

For indoor and outdoor shooting. Filter colors: light grey, grey, darkgrey, C 41 blue, C 41 UV, yellow, green, orange, brown, C 41 peach.

- Improved handling by new filter ring.
- Adjusting range 0.8 to 1.8 mm.
- 15 Lamella segments.

Art.-Nr.: 9786-O

Art.-Nr.: 9786-S



9786-O



9786-S

## ahg-IRIS DISC TWIN with 10 color filters and full polarisation:

Like 9786 but with integrated polarisation filter.

- Improved handling by new filter ring.
- Adjusting range 0.8 to 1.8 mm.
- 15 Lamella segments.

Art.-Nr.: 9787-O

Art.-Nr.: 9787-S



9787-O



9787-S

## Good adjustment... means good sighting!

The variably adjustable iris disc grants an optimum focussing control. Focus change can be watched while turning the iris.

The best results are achieved from 1.0 to 2.0. If the shooter's eye is far away from the sight, e.g. in prone position, more than 2.0 might be useful. Under 1.0 you think that the peep picture is not sharp, not round but angular or dusty. This physical effect is due to the small diameter. When checking the iris at its smallest diameter with the help of a magnifying glass, you will see that the peep is perfectly round. This extremely small diameter is rarely used.

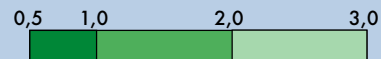

Very dark.  
Blurred target picture.



Best target picture.  
Optimum adjustment possible.

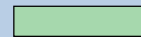

Large iris diameter.  
Long distance from peepsight to eye.



43



# ahg-IRIS DISCS

with removable color ring

## ahg-IRIS DISCS:

All ahg-iris discs produced from 1999 on have a color ring which can be unscrewed and replaced by rings of other colors (Art.-Nr.: 9782/9783).

These colored rings will enable you to react promptly to any change of light conditions in the shooting range in order to obtain a more balanced target and a better contrast.

A light color ring, for example, will have a positive effect on the target at a dark shooting range.

44



9775-S



9779-S



## ▲ ahg-IRIS DISCS:

- Eyepiece with substitute color ring SMALL.
- Adjusting range 0.5 - 3.0 mm.
- 15 lamella segments
- Extra short.

**Art.-Nr.: 9775-O**

**Art.-Nr.: 9775-S**

## ▲ ahg-IRIS DISCS:

A combination of the ahg-iris aperture 9775 with 5 glass filters of the colors light grey, dark grey, orange, yellow, C 41 blue.

- Eyepiece with substitute color ring SMALL.
- Adjusting range 0.5 - 3.0 mm.
- 15 lamella segments.

**Art.-Nr.: 9779-O**

**Art.-Nr.: 9779-S**



9781-S



## ▲ ahg-IRIS DISCS

With 5-color filter and full polarisation:

- Eyepiece with color ring SMALL.
- Adjustment range 0.5 - 3.0 mm.

Color filters:

- Light grey, dark grey, orange, yellow, C 41 blue.

Polarisation:

- Two independently adjustable pol-filters.
- Incremental dimming.
- Separate adjustment for polarisation and dimming.
- Filters may be swung aside giving a direct target view.
- Also available with (S) black eye piece.

**Art.-Nr.: 9781-O**

**Art.-Nr.: 9781-S**



## ▲ ahg-IRIS DISCS:

With polarisation filter.

- Eyepiece with substitute color ring SMALL.
- Adjusting range 0.5 - 3.0 mm.
- 2 individually adjustable polarisation filters.
- Variably adjustable regulation of brightness.
- Blacking out and polarisation can be set independently.
- Both discs can be put in off-position for free peep.

**Art.-Nr.: 9780-S**



## ▲ For BUSK/SAUER Rear Sight:

ahg-IRIS with 5-color filter:

**Art.-Nr.: 9779-A/O**

ahg-IRIS APERTURE:

**Art.-Nr.: 9775-A/S**





If you need irises or apertures with another size of thread please do not hesitate to contact us!



45



**ahg-HAWK 4,5 OPTICAL ADAPTER:**

To see like a hawk, who doesn't want that?

The HAWK 4,5 is an optical adapter which facilitates an upgrading of every CENTRA-iris disc.

This adapter magnifies by 1,5 and facilitates an equalization of the rear sight from -4,5 to +4,5. In some cases this adapter can replace glasses.

**Art.-Nr.: 9580**



**ahg-IRIS:**

- Variably adjustable from 0.8 - 2.2 mm.
- The peep picture is 100% round.
- For all current rear sights.

**Art.-Nr.: 9510**



**ahg-IRIS:**

- With 5-color filter.
- Yellow, green, brown, grey, light grey.
- Increased contrast of target picture.
- If no filter is necessary this iris can be adjusted to free peep picture.

**Art.-Nr.: 9560**



**ahg-IRIS:**

- With full polarisation.
- Variable adjustment of brightness.
- Filter reduces disturbing reflexion.
- It is possible to use this iris with free peep picture.

**Art.-Nr.: 9550**



**ahg-IRIS:**

- With 5-color filter and full polarisation.
- Individual adjustment of the optical device to the light conditions.
- Polarisation and dimming can be adjusted separately thanks to two polarisation discs.
- A free peep picture is also possible if the weather situation is bad.

**Art.-Nr.: 9565**



**ahg-IRISBLENDE:**

- With optical device.
- Magnifies 1.5x, ranges from -3.5 to +3.5 D.
- Adjustment range 0.8 to 2.2 mm.
- Perfectly circular target image.
- Fits current rear sight models.
- Overall size: extra short.

**Art.-Nr.: 9530**



**ahg-IRIS:**

- With 5-color filter and optical device.
- Like Art. 9560, but with optical device.

**Art.-Nr.: 9570**



**ahg-ADAPTER:**

For irises with optical device: (Art. 9530, 9570, 9575, 9551), to be used also without optical device.

**Art.-Nr.: 9577**



**ahg-IRIS:**

- With full polarisation and optical device.
- Like Art. 9550, but with optical device.

**Art.-Nr.: 9551**



**ahg-IRIS:**

- With 5-color filter, optical device and full polarisation.
- Reliably compensates varying light conditions.
- Separate setting of polarisation and dimming.
- In case of suboptimal lighting conditions filters may be disengaged.

**Art.-Nr.: 9575**

**ahg-OPTICAL ADAPTER:**

- Magnification 1.5
- Adjustable from -4.5 to +4.5 diopter.

**Art.-Nr.: 9578**

Only to be used for Art.-No: 9530, 9570, 9575 and 9551.



# ahg-ACCESSORIES

for better aiming

## ahg-SIGHT-TRACK BASE: ▶

This new base has the following advantages:

- Long sight tunnel prevents from disturbing light.
- Bridging of the loading platform stabilises the receiver, thus the vibrations of the shot are reduced.
- Additional weight above the axle of the barrel in front of the normal sight.
- Top Design in connection with increase in value of your rifle.
- Approx. 20 mm more for more possibilities to mount your sight set.
- Better recognizing of aiming and canting faults due to longer front sight tube.

Also available as a complete rear sight with 10 or 20 click.

With 10 click.

**Art.-Nr.: 9797-U1**

With 20 click.

**Art.-Nr.: 9797-U2**

Sight-Track-Base.

**Art.-Nr.: 9797-U3**



Sight-Track-Base.



## ahg-HANDSTOP INTEGRAL: ▶

You need the right equipment for a successful competition.

The ergonomically designed ahg-hand-stop INTEGRAL will make a contribution to this goal and help you to perform beautifully.

This handstop is adjustable in all directions (horizontally, vertically and radial) and thus can distribute the high power that is transmitted from your shooting sling to your hand.

Precise shooting is possible when you are not distracted by an aching hand.

**Art.-Nr.: 6229**





## ahg-BARREL WEIGHT STABILISATOR: ▶

This stabilizer reduces the recoil movement of your rifle. With the help of the weights you may tune the lever power individually in axial, vertical and horizontal direction.

When the enclosed two steel supports are screwed to the stabilizer, it may be used as bipod.

**Art.-Nr.: 8020**

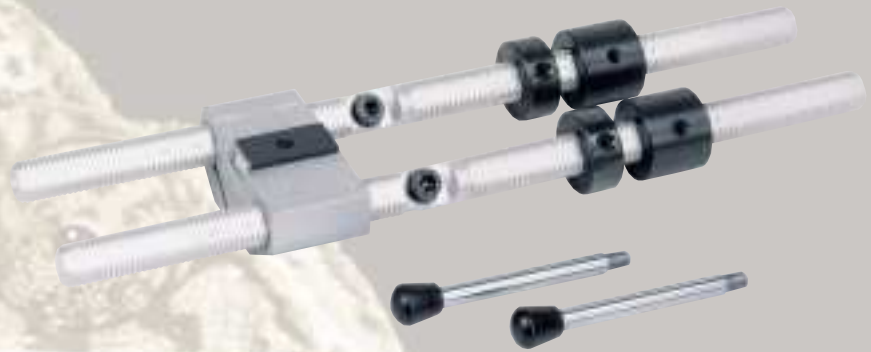

### ▲ ahg-SPIRIT LEVEL:

Can be used to control canting without having to turn the head. It is attached to the rail of the action in front of the rear sight.

- Knurled nut ensures easy and variable adjustment.
- Easy centering of the front sight because the spirit level is not visible in the target picture.

**Art.-Nr.: 9506**



### ▲ ahg-SPIRIT LEVEL:

- Two sizes M18 and M22.
- Adjustment without tools.
- Exact reproduction of various canting angles.

For M18 front sight.

**Art.-Nr.: 9503**

For M22 front sight.

**Art.-Nr.: 9504**



### ▲ ahg-BARREL WEIGHT:

- Weight: 200 g.
- For diameter 20 - 22,5 mm. e.g. for Anschütz Mod. 1407 - 1907, 2001 - 2002.
- Felt stripes avoid scratches.

**Art.-Nr.: 8007**



47

# ahg-ACCESSORIES

best quality for professionals



48



## ▲ ahg-REAR SIGHT KNOB-SET:

In various colors.  
- For ANSCHÜTZ rear sight 6805 / 7002.

**Art.-Nr.: 4806-2** Lilac.

**Art.-Nr.: 4806-3** Blue.

**Art.-Nr.: 4806-4** Red.

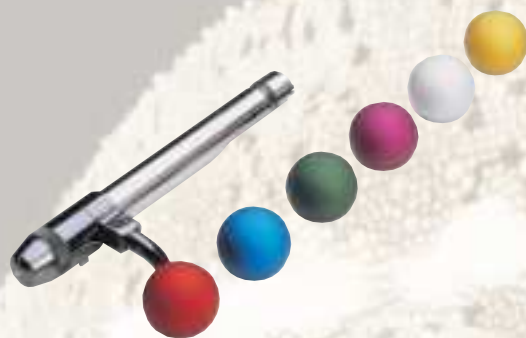

## ▲ ahg-ALUMINIUM BALLS:

For the bolt handle.

**Art.-Nr.: 4804-1** Gold.

**Art.-Nr.: 4804-2** Lilac.

**Art.-Nr.: 4804-3** Blue.

**Art.-Nr.: 4804-4** Red.

**Art.-Nr.: 4804-5** Green.

**Art.-Nr.: 4804-6** Silver.

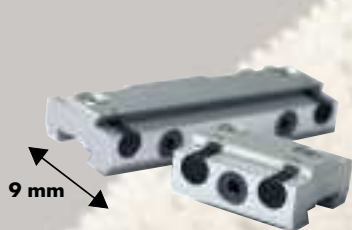

## ▲ ahg-HIGH SIGHT BLOCK TRACK:

- Variable lateral adjustment.  
- Elevation 9 mm.

For Anschütz rifles.

**Art.-Nr.: 6924**

For FWB rifles.

**Art.-Nr.: 6925**



## ▲ ahg-HIGH SIGHT BLOCK:

- 100 % tight.  
- For ANSCHÜTZ Mod. 1903 - 2013.  
- Height only 4 mm.

**Art.-Nr.: 6923**



## ▲ ahg-BOLT HANDLE-DESIGN:

To screw on the bolt handle.

**Art.-Nr.: 4805-2** Lilac.

**Art.-Nr.: 4805-3** Blue.

**Art.-Nr.: 4805-4** Red.



## ◀ ahg-UNIVERSAL-CARRIER:

- Suitable for all Anschütz stocks starting from model series 1413 - 2013 (fix version).  
- Individual adaptation of the carrier, axially, horizontally and vertically adjustable.  
- Suitable for all common aluminium, rubber and hook butt plates.

**Art.-Nr.: 9796**



## ahg-CHEEK PIECE MECHANISM / BENCH REST SHOOTING:

Especially while bench rest shooting, the sturdy and continuously adjustable (towards the back, up to 13 cm) mechanism is being mounted to the original Anschütz cheek piece adjustment (2213-8200) in order to optimize positioning.

The continuous adjustment enables the shooter to find the optimal head position. The reverse adjustable cheek piece therefore offers sturdy, repeatable positioning; a relief for neck muscles.

Any previous functions of the cheek piece adjustments are not influenced and can be used as usual.

Suitable for all Anschütz rifles which are equipped with the cheek piece adjustment 2213-8200.

**Art.-Nr.: 1025**



**NEW!**



**NEW!**



## ahg-EYE II:

Variable Sight Carrier.

This new carrier allows aiming with the left eye for right hand shooters, or vice versa. Perfect position and distance to the eyes by adjustable windage and rotating carriers for rear and front sight. Mounting and demounting of the front sight carrier for transportation of the weapon is very easy as a center-ring fastens the exact position of the carrier.

When ordering, the diameter of the barrel has to be stated, as the front sight carrier is being adjusted to that barrel. Total weight: 245 g.

**Art.-Nr.: 6927**



49



## ahg-REAR SIGHT RAIL TELE:

To move the rear sight back for benchrest shooting.

For Anschütz rifles.

**Art.-Nr.: 1003**

For FWB rifles.

**Art.-Nr.: 1004**



## ahg-WEDGE FOR ANSCHÜTZ ALU STOCK:

Small bore rifles.

This ahg-fore-end wedge can be easily attached just by sliding on to the Anschütz small bore rifle alu-stocks.

By shifting your hand (back and forth) you may change your position individually, thus enabling you to react quickly and

efficiently to the conditions in your shooting range. Especially advantageous for shooters with short arms.

Weight: 350 g.

**Art.-Nr.: 1021**

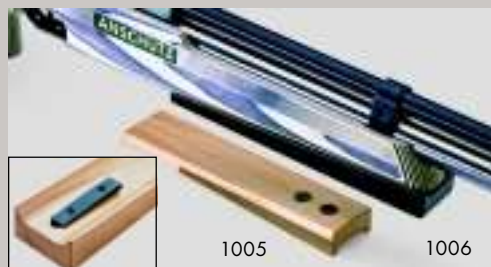

## ahg-WEDGE:

- For Anschütz and FWB air rifles.  
- To be inserted into aluminium rail and tightened.

**Art.-Nr.: 1005** Hardwood.

**Art.-Nr.: 1006** Hardwood black.



## ahg-WEDGE:

For Anschütz air rifle alu-stocks Mod. 2002.

**Art.-Nr.: 1009** Hardwood black.

**NEW!**



## ahg-FOREEND RAISER BLOCK:

For aluminium-stock 2213/2313. ahg-Anschütz has developed a forend raiser block which can be fixed to the alu-stock 2213 or 2313. Just put it into the alu-rail and get fixed with 4 screws.

**Art.-Nr.: 1022**

# ahg-ACCESSORIES

best quality for professionals



50



## ▲ ahg-HANDSTOP:

With sling swivel.  
- Push button disengages swivel which remains on the sling.

**Art.-Nr.: 6225**



## ▲ ahg-HANDSTOP:

With detachable sling loop.  
- Suitable for:  
Anschütz, Diana, Feinwerkbau, Steyr.

**Art.-Nr.: 6226-1**



## ▲ ahg-HANDSTOP:

Version like Art. 6226-1 in different colors.

**Art.-Nr.: 6226-2** Lilac.

**Art.-Nr.: 6226-3** Blue.

**Art.-Nr.: 6226-4** Orange.



**NEW!**



## ▲ ahg-PALM REST:

A proven and tested, individually adjustable palm rest for standing position. The support raises the palm rest for an additional 25 mm at the maximum. The strong swivel joint with four screws allows combined adjustments of the palm

rest on three axes, thus enabling an optimal transmission of power to the supporting hand. The supporting surface is additionally coated on both sides with a profiled anti-slide rubber.

**Art.-Nr.: 9795**

**NEW!**



## ▲ ahg-BI-POD:

The BI-POD ensures a safe standing of the weapon when prone shooting. Using anti-slide rubber balls, the weapon has a secure position. Both supports can be folded together for transportation.

**Art.-Nr.: 9793**

## ahg-MONOFRAME: ▶

For 25 mm Spectacle Lens.  
Your individual, improved spectacle lens is put in the ahg-monoframe.  
With the help of a set adapter and a clamp, the ahg-monoframe is mounted centrally in front of the sight disc or the iris disc. Therefore, your sight defect is corrected directly on the iris disc, consequently aiming mistakes are avoided to a large extend.  
Only spectacle lenses with an outer diameter of 24 mm can be used.  
ahg-monoframe does not correspond to the presently valid rules of DSB and ISSF but can be used in many other disciplines.

**Art.-Nr.: 9450**

**NEW!**







**ahg-SPECIAL-TRIGGER SHOE:**

- Constant finger position.
- Absolute stability of trigger weight.
- Extremely quick shot release.
- Short trigger travel.
- Reduced force for first stage pull.



Suitable for FWB and Hämmerli.  
**Art.-Nr.: 9715**

Suitable for Anschütz 1907 - 2013 with trigger blade.  
**Art.-Nr.: 9716**



**ahg-TRIGGER SHOE:**

For Anschütz triggers 5018/5071.

- Variable height adjustment.
- 360° rotating trigger ball.
- Variable length adjustment of trigger blade. (better "forward" adjustment than the original trigger blade).

**Art.-Nr.: 9717**



**ahg-SIGHT RAISER BLOCK XXL:**

New shooting comfort will be experienced with this sight raiser block XXL (20 mm) which offers many advantages in standing and kneeling positions. The contortion of the head when aiming is reduced to a minimum, thus avoiding any tension in the neck and in the back. Use of this raiser block is permitted for all air and small bore rifle disciplines.

For Anschütz rifle Mod. 1903-9003.  
**Art.-Nr.: 6922**

For FWB rifle.  
**Art.-Nr.: 6921**

For Walther rifle.  
**Art.-Nr.: 6920**



**ahg-STOCK WEIGHT:**

The weight will be inserted in the groove of the stock and fixed with two screws.

- For Anschütz model 2002 Compressed Air Alu.
- Approx. 190 g.
- With individual engraving of the name.

Weight with engraving.  
**Art.-Nr.: 8009**

Weight without engraving.  
**Art.-Nr.: 8010**

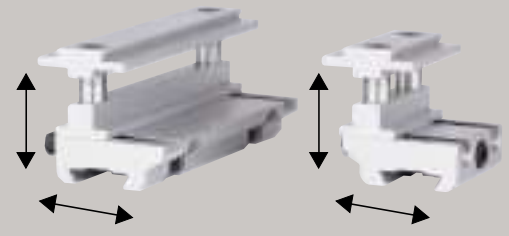

**ahg-SIGHT RAISER BLOCK TRACK MAX:**

Facilitates horizontal (left - right) adjustments of approx. 20 mm. Additional vertical (high - low) adjustments by means of spacers - minimum 22 mm to maximum 27 mm. These individual adjustments allow an even more perfect adjustment of the sights, especially in prone or kneeling position. Tensions in the neck or back muscles can almost be avoided completely with such a perfect adjustment. The vertical adjustments can be mounted step by step in 1 mm clicks.

The sight set contains:  
4 cylinder screws each M3 x 18 and M3 x 20.  
4 distance discs each 4 mm, 2 mm and 1 mm in thickness.

Available for Anschütz rifles.  
**Art.-Nr.: 6926**



# ahg-ACCESSORIES

best quality for professionals



▲  
**ahg-TRIGGER PRESSURE GAUGE:**

- High precision gauge for measuring trigger weight.
- Equipped with weight indicator for easy reading-off trigger weight.

Trigger pressure gauge range:  
gauge:

**Art.-Nr.: 540** 5 - 50g.

**Art.-Nr.: 541** 25 - 250g.

**Art.-Nr.: 542** 50 - 500g.

**Art.-Nr.: 543** 200 - 2000g.



▲  
**ahg-UNI TOOL:**

With all common hex keys and one screw driver for all adjustments at the rifle.

- Hex key SW2, SW3, SW4 and one screw driver.

**Art.-Nr.: 1200**



▲  
**ahg-TRIGGER PRESSURE GAUGE:**

- Consisting of 4 parts. Air pistol 500 g, standard pistol 1000 g and target pistol 1360 g can be checked with one gauge.
- Shock absorbing suspension coil.
- Incl. 140 g extra weight and wooden case.

**Art.-Nr.: 545**



▲  
**ahg-FLIP-UP BLINDER WITH IRIS:**

- Flip-up blinder.
- Variably adjustable iris.
- Rubberized clip for safe and non-slipping clamping to all current glasses.

**Art.-Nr.: 9778**



◀ **ahg-VELOCIMETER:**

- For air rifles and pistols.
- Ideal for coaches to measure the speed of the air rifle.

**Art.-Nr.: 547**



▲  
**ahg-TORQUE WRENCH:**

- New design helps to tighten the stock screws of target rifles in order to grant a constant torque.
- Adjusting range from 4 - 12 Nm.

**Art.-Nr.: 4506-SW4**

Extra insert SW4:

**Art.-Nr.: 4505-1**



▲  
**ahg-TORQUE WRENCH:**

- Like Art. 4506-SW4, but with insert of size SW5.
- For big bore rifles such as Sauer.

**Art.-Nr.: 4506-SW5**

Extra insert SW5:

**Art.-Nr.: 4505-2**



▲  
**ahg-ABDECKSCHEIBE:**

- Flip-up blinder for the non-aiming eye.
- With rubberized clip for safe and non-slipping clamping to all current glasses.

White.

**Art.-Nr.: 9777-1**

Transparent.

**Art.-Nr.: 9777-2**



# ahg-SHOOTING GLASSES Jäggi Nova

helpers for your eyes

Practical design, simple handling and extraordinary solidity are the main features of these successful ahg-shooting glasses.

## JÄGGI NOVA SHOOTING GLASSES

come up to these expectations. A wide range of accessories ensures optimum conditions for all shooters even with strong visual defects and under extreme light conditions at the range. The glasses can be used for rifle and pistol shooting and shooting with open sight. Only change the lens frame - this can be done quickly and easily without any tools. The square-headed guide of frame and bows prevent the lens frame from unintentional movement or adjustment while shooting.

Supplied in a small handy case.

For rifles, with lens frame 42 mm.  
**Art.-Nr.: 9000-42**

For rifles, with lens frame 25 mm.  
**Art.-Nr.: 9000-25**

For pistols, with lens frame 42 mm.  
**Art.-Nr.: 9002-42**



Laser scaling on frame, lens frame and nose piece facilitate adjustments remarkably.

All detachable color filters are simply being clipped on to the lens frame and available in sizes 25, 31 and 42 mm.

	25 mm.	31 mm.	42 mm.
Yellow.	<b>Art.-Nr.: 9061-25</b>	<b>Art.-Nr.: 9031-31</b>	<b>Art.-Nr.: 9040-42</b>
Orange.	<b>Art.-Nr.: 9063-25</b>	<b>Art.-Nr.: 9035-31</b>	<b>Art.-Nr.: 9042-42</b>
ACE Amethyst.	<b>Art.-Nr.: 9066-25</b>	<b>Art.-Nr.: 9038-31</b>	<b>Art.-Nr.: 9045-42</b>
UV-400 SAR.	<b>Art.-Nr.: 9067-25</b>	<b>Art.-Nr.: 9086-31</b>	<b>Art.-Nr.: 9046-42</b>
Green shot.	<b>Art.-Nr.: 9068-25</b>	<b>Art.-Nr.: 9069-31</b>	<b>Art.-Nr.: 9070-42</b>



### ▲ LENS FRAME for rifle:

31 mm / 25 mm.

**Art.-Nr.: 9016-31**

**Art.-Nr.: 9014-25**



### ▲ LENS FRAME for pistol:

31 mm / 42 mm.

**Art.-Nr.: 9015-31**

**Art.-Nr.: 9017-42**



### ▲ LATERAL BLINDERS:

Optimal protection against lateral blinding by fastening side blinders to the side of the frame - even corresponds to DSB and ISSF rules.

**Art.-Nr.: 9081**



### ▲ IRIS DISC adjustable:

The iris disc is screwed on the Titan frame. This reduces the weight remarkably and improves the wearing comfort.

**Art.-Nr.: 9032** 25 mm.

**Art.-Nr.: 9032-L**

**Art.-Nr.: 9033** 31 mm.

**Art.-Nr.: 9033-L**

**Art.-Nr.: 9034** 42 mm.

**Art.-Nr.: 9034-L**



### ▲ NOSE PIECE / NOSE PIECE LONG:

**Art.-Nr.: 9013**



### ▲ EYESHADE:

For right hand and left hand shooters.

**Art.-Nr.: 9084K**



53

# ahg-ACCESSORIES

all you need

54

NEW!

## ahg-LANYARD KEY-TAG:

- ANSCHÜTZ design.
- Quick disconnect from tag and strap.

Art.-Nr.: 2010

## ahg-SAFETY-BOX:

- Safety-Box for pellet cans. To avoid the problem of having to handle the adhesive strips on the cans. Simply put the can in the safety box.

Art.-Nr.: 2101

## ahg-PIN:

- With butterfly closure.
- Diameter 15 mm.
- Soft-enamel, iron punched.
- With ahg-Anschütz motive.

Art.-Nr.: 2001

## RIFLE-PIN 2313:

- Length 56 mm.
- With butterfly-closure.

Art.-Nr.: 2005

## RIFLE-PIN 1912:

- Length 56 mm.
- With butterfly-closure.

Art.-Nr.: 2002

## ahg-PELLET-BOX:

- To store your pellets.
- Easy handling.
- Suitable for cal. 4.5 mm (.177).
- For 100 pieces of Diabolo pellets.

Art.-Nr.: 1001

## ahg-MATCH DIABOLOS:

- Target pellets for air rifle and air pistol, made by H&N.
- Available in sizes 4.5 mm.
- For air rifle and pistol, Box with 500 pellets.

Art.-Nr.: 2102

## ahg-FINALE MATCH DIABOLOS:

- Final target pellets for air rifle and air pistol, made by H&N.
- Available in sizes 4.48 / 4.49 and 4.5 mm.
- For air rifle and pistol.
- Box with 500 pellets.

Art.-Nr.: 2100

## ahg-TIEBAR:

- Length 66 mm.
- Rifle Modell 2313.

Art.-Nr.: 2006

## ahg-KEY PENDANT RIFLE:

- Key pendant with rifle Mod. 1912.
- Elegant design.
- In new 3 D stamp technique.
- With ring.

Art.-Nr.: 2003

## ahg-PROTECTION WRAPPING for Compressed Air Cartridges:

- This protection wrapping can be adjusted from 35,5 to 57 length cm and protects the cartridge against damage, dust and moisture. Therefore, valves and threads remain protected. Suitable for Anschütz, FWB, Walther and other cartridges up to a diameter of 33,5 cm.

## ahg-BACK-PACK:

- A fashionable back pack for the transportation of all your equipment. On the side it has 2 elastic mesh for holding bottles. A pocket on the front has room for writing materials.

Dimensions:  
38 x 28 x 14 cm.

Art.-Nr.: 293

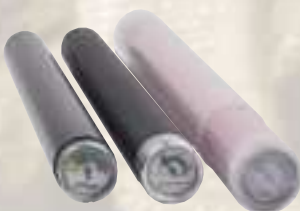



## ahg-SHOOTING BAG with wheels: ▶

The ahg-shooting bag with wheels accommodates all the necessary shooting equipment for the need of a travelling shooter.

- Sufficient space for jacket, pants, boots, scope, glove and many other things.
- Robust construction of the bottom (5 mm wood).
- 2 wheels in combination with belts for a lot of different transportation possibilities.

- Pull-out grip for easy pulling.

Dimensions:  
70 x 40 x 33 cm.

**Art.-Nr.: 290**



## ahg-SPORT BIG: ▶

The ahg-sport bag is opened up in the middle. One side can be locked by zipper, here you may store your jacket and pants lengthwise, both will thus last longer. The other side is divided in three compartments, each one can be locked by zipper.

You will see that it is no longer necessary to rummage your bag for the things you are looking for. Small compartments on one side of the bag may be used for targets, portfolios etc. The bag has skate-board rolls and an extensible frame grip for easy pulling.

Measurements:  
80 x 40 x 34 cm.

**Art.-Nr.: 292**



## ahg-ACCESSORY BAG: ▶

For sight sets and hook butt plates.

Developed for safe storage of accessories such as sights and butt plates. The padding of the bag protects accessories and prevents them from slipping. The bag will fit perfectly into the side pocket of our Sport Bag art. 292.

Measurements:  
22 x 22 x 10 cm.

**Art.-Nr.: 295**



## ahg-HUNTER'S BAG: ▶

Big travel bag for hunters and shooters with extra compartment for the weapon case and many additional compartments. A bag suitable for everything, especially for travels by plane. With telescope handle and large wheels.

Measurements:  
91 x 42 x 38 cm.

**Art.-Nr.: 294**



55

# MEC ACCESSORIES

best quality - from professionals for professionals



▲ MEC „TUBE“:  
Sighting line extension for  
air rifles:

- Extends the sighting line to the maximum.
- Variably adjustable sighting line.
- Variations of weight and balance.
- Reduction of recoil.



MEC TUBE  
for Anschütz air rifles.

**Art.-Nr.: 9900**

MEC TUBE for FWB.

**Art.-Nr.: 9901**

MEC TUBE for Walther.

**Art.-Nr.: 9902**



▲ MEC „CONTACT III“:

- Aluminium butt plate.
- Variably adjustable to any position.
  - Very good adhesion.
  - Suitable for all common air rifles.

**Art.-Nr.: 9903**



▲ MEC „VISOR“:

- Visor made of neoprene.
- Low weight visor against scattered light.
  - Can be shaped as desired.

Material: 100% PU.

**Art.-Nr.: 9905**



▲ MEC „TRIGGER“:

- Trigger Shoe
- Can be tilted to the side.
  - Tongue can be moved freely.
  - Horizontal grooves for better adhesion.
  - Optimum width.
  - Variable rings for height adjustment.
  - Light alu construction for function and stable fixing.

Trigger shoe for Anschütz.

**Art.-Nr.: 9906**

Trigger shoe for FWB.

**Art.-Nr.: 9907**



▲ MEC HANDSTOP:

- Can be moved to the side, i.e. the hand can individually be positioned at the stock.
- Variable height; according to the referring anatomy of the hand the height can be adjusted with the help of spacers.
- The special shape minimizes pain.
- Two possibilities to fix the sling. It is thus possible to have the sling pull from the center (sling is fixed in the screw) or the sling pull does not come from the center as the hand stop has been moved to the side.
- Scales for the movement to the sides.

**Art.-Nr.: 6227**



▲ Book  
„WAYS OF  
THE RIFLE“:

- Vol. 1.
- Literature for shooters.

**Art.-Nr.: 9911**



▲ Book  
„AIR RIFLE  
SHOOTING“:

- Literature for shooters.

**Art.-Nr.: 9912**



▲ MEC „FREE POSITION“:

- Butt plate for super match and sport rifles.
- Unsurpassed variations.
  - Wing elements can be adjusted in height and angle and can be turned around the axis.
  - Suitable for all common small bore match rifles.

**Art.-Nr.: 9904**



▲ MEC PALM REST CHAMPION:

- Adjustable in all directions.
- Exchangeable hand rest.
  - Hand rest swinging radially to the center line of the barrel.

**Art.-Nr.: 9910**



# ahg-F27A Challenger

the new rifle for new challenges



57

## ahg-F27A CHALLENGER:

This highly accurate small bore target rifle has been developed in close cooperation with experienced target shooters and the knowledge resulting from it. The use of high quality material combined with solid and tried and tested technology offers the precision necessary to be successful not only to top class shooters.

- The centred locking mechanism of the straight pull action with the receiver offer an optimum absorption of the force created at shot release.
- Thumbhole stock adjustable in length, non-stained, with versatile butt plate and cheek piece adjustments as well as a flat forend raiser lock 4856 and individually adjustable hook butt plate.

- The well-known Anschutz hook butt plate 2213-8700 completes both stock variations of the model F27A Challenger at an optimum. It is possible to adjust the hook butt plate horizontally, vertically and radially very quickly. In addition, the weight distribution can be optimised individually by the new ahg-stabilizer for both stock variations.

**Art.-Nr.: F27A-660-ahg**

**Art.-Nr.: F27A-690-ahg**



Delivered with:  
F27A in hardwood stock with front sight Swing 9755, forend raiser block 4856 and ahg-handstop Integral 6229, without rear sight.  
Accessories:  
ANSCHÜTZ rear sight art. 7002/20.



Barrel extension Art. Nr.: 4513.  
Extension by 11 cm, barrel diameter 23 mm.  
Supplied without front sight and base.

**Art.-Nr.: 4513**



**Art.-Nr.: F27A-660-G+E**

**Art.-Nr.: F27A-690-G+E**

**Art.-Nr.: F27A-690-Links**

G & E alu stock  
Delivered with:  
F27A in G&E alu stock with front sight Swing 9755, forend raiser block 4856 and ahg-hand stop Integral 6229, without rear sight.  
Accessories:  
ANSCHÜTZ rear sight art. 7002/20.

Model	Stock version	Caliber	Barrel length	Rifling	Total length	Length of sighting	Weight	Version
F27A-660	ahg	.22 l.r.	66 cm / 25.9"	66 cm / 25.9"	106-109 cm / 41.7"-42.91"	80 cm / 31.4"	5,3 kg / 11.66 lbs	Single loader
F27A-660	G & E Alu	.22 l.r.	66 cm / 25.9"	66 cm / 25.9"	106-109 cm / 41.7"-42.91"	80 cm / 31.4"	5,3 kg / 11.66 lbs	Single loader
F27A-690	ahg	.22 l.r.	69 cm / 27.1"	69 cm / 27.1"	109-112 cm / 42.91"-44.09"	83 cm / 32.67"	5,6 kg / 12.34 lbs	Single loader
F27A-690	G & E Alu	.22 l.r.	69 cm / 27.1"	69 cm / 27.1"	109-112 cm / 42.91"-44.09"	83 cm / 32.67"	5,6 kg / 12.34 lbs	Single loader
F27-A-690 Links	G & E Alu	.22 l.r.	69 cm / 27.1"	69 cm / 27.1"	109-112 cm / 42.91"-44.09"	83 cm / 32.67"	5,6 kg / 12.34 lbs	Single loader



# ANSCHÜTZ TARGET RIFLES

for real champions

58



## ▲ MODEL 9003 PREMIUM COMPRESSED AIR:

The world's best shooters contributed to the development of the new ANSCHÜTZ Match Air Rifle 9003 Premium.

- Tension free connection and vibration damping fixing of the barreled action in the aluminium stock through Soft Link, shock absorber pads.
- Absolutely maintenance-free stabilizer.
- Ultra-short lock time.
- New and innovative safety concept for the loading process.
- Dry-firing device.
- Adjustable forend.
- Complete PRO-Grip equipment.
- Patented butt plate and cheek piece adjustment.
- Patented air filter against pollution.
- Various stock decoration stickers to choose from.

## ▲ MODEL 8002 COMPRESSED AIR Alu PRO-Grip:

This new compressed air rifle corresponds to all modern requirements of today's competition air rifles and the latest state of technological development:

- The barreled action is embedded into the alu stock via vibration absorbing elastomers; vibrations which occur during shooting in the barreled action of the air rifle are thus effectively absorbed.
- The very fast lock time of the 2002 Compressed Air has been reduced again considerably
- The newly developed trigger unit offers a constantly reliable trigger service even during fluctuations in temperature.
- The barreled action is only cocked when



the action is closed completely; if the cocking lever is not closed completely, it jumps back automatically and a shot release is not possible.

- The dry firing mode can only be actuated in cocked condition; it is therefore not possible to un-cock the barreled action by pushing the dry firing switch once the trigger has been released, thus, an accidental shot release is avoided.
- Air filters protect pressure regulator and valve from impurities and thus avoid malfunctions.
- Grip, cheek piece and fore-end stock are made of PRO-Grip® material.

Model	Caliber	Barrel length	Rifling	Total length	Length of sighting	Weight	Art.-Nr.:
8002 Compr. Air Alu PRO-Grip, Grip large	4,5 mm	64 cm	42 cm	108 cm	78 cm	4,5 kg	<b>560.2935</b>
8002 Compr. Air Alu PRO-Grip, Grip medium	4,5 mm	64 cm	42 cm	108 cm	78 cm	4,5 kg	<b>560.2936</b>
8002 Compr. Air Alu PRO-Grip, Grip large, left	4,5 mm	64 cm	42 cm	108 cm	78 cm	4,5 kg	<b>560.3935</b>
9003 Premium Compr. Air, Grip large	4,5 mm	64 cm	42 cm	108 cm	78 cm	4,5 kg	<b>560.4990</b>
9003 Premium Compr. Air, Grip medium	4,5 mm	64 cm	42 cm	108 cm	78 cm	4,5 kg	<b>560.4995</b>

## AIR PISTOLS

sporty and elegant

### MODEL LP.@ ANSCHÜTZ COMPRESSED AIR:

The new compressed air pistol with shot stabilizer and new muzzle compensator.

#### Trigger:

With the precise adjustment of the trigger it is possible to adjust trigger weight and trigger stop as well as the relation between first stage weight and trigger weight according to the individual requirements. The trigger weight is 500 g and corresponds to the ISSF shooting regulations.

#### Shot stabilizer:

The compensator facilitates the control of the muzzle reaction. The pulse, which is created by the shot, is eliminated by the stabilizer.

#### Sight set:

The sighting line can be adjusted individually for front and rear sight. The triangular aperture can be adjusted to 3.5, 4.0 and 4.5 mm and in length. The width of the sight blade is adjustable up to 5 mm.

#### Grip:

The Morini grip is adjustable in all directions and can be tilted, thus enables a comfortable and natural handling. In addition, the palm rest is adjustable in height. Test this grip!

#### Supplied with:

Triangular aperture, weight rod, 2 compressed air cylinders with manometer, special grease, screw driver, instruction leaflet with test target.



**Art.-Nr.: 6700001** Grip S.

**Art.-Nr.: 6700002** Grip M.

**Art.-Nr.: 6700003** Grip L.



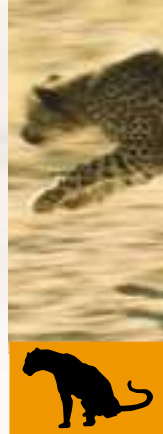

1907 Walnut with  
Alu Butt Plate 4759.



1912  
Sports Rifle.



2013/690 in stock 2313  
Aluminium, Color.



1913 in stock 2213  
Aluminium, Color.



▲  
**ANSCHÜTZ  
SMALL BORE TARGET  
RIFLES:**

Target shooters all around the world use the renowned Anschütz target rifles with the famous Anschütz Match 54 action.

**SMALL BORE TARGET RIFLE 1907:**

- With new butt plate and cheek piece adjustment.
- Extremely short locktime.

**SMALL BORE SPORT RIFLE 1912:**

- For the Sport Rifle discipline up to 6.5 kg.
- With famous barreled action of Mod. 1907.

**SMALL BORE SUPER MATCH  
2013/690:**

- With 690 mm barrel length.
- Extremely short locktime.

▲  
**ANSCHÜTZ MODEL  
1913 in new Alu-Stock  
2213:**

Many national and international top results were achieved with the Anschütz 1913 Super Match barreled action. Now this barreled action is also available in the new Anschütz aluminium stock 2213.

- Extraordinary butt plate and cheek piece adjustment.

- Stock weight closer to the barrel axis therefore the recoil is absorbed at shot release.

- Pistol grip available in two sizes.
- Grip adjustable to the back, front and side.

- Stock 2213 also available with the Anschütz barreled action 1907.



Model	Caliber	Barrel length	Rifling	Total length	Sighting line	Weight	Art.-Nr.:
1907 Match Rifle	.22 l.r.	66 cm	66 cm	113 cm	77 cm	4,8 kg	<b>201.0924</b>
1912 Sport Rifle	.22 l.r.	66 cm	66 cm	106 - 109 cm	77 cm	5,2 kg	<b>201.6920</b>
2013/690 in alu-stock 2313	.22 l.r.	69 cm	69 cm	112 - 115 cm	80 cm	5,7 kg	<b>200.5875</b>
1913 in alu-stock 2213	.22 l.r.	69 cm	69 cm	112 - 115 cm	80 cm	5,6 kg	<b>202.5875</b>

# ANSCHÜTZ ACCESSORIES

ahg offers the complete ANSCHÜTZ-Line



▲ IRIS DISC:

**Art.-Nr.: 7001060**



▲ IRIS DISC:

With 5-color-filter.

**Art.-Nr.: 7001030**



▲ IRIS DISC:

With 5-color-filter and polarisation filter.

**Art.-Nr.: 7001050**



▲ ANSCHÜTZ SIGHT SET:

- Complete sight set with front sight 6832, Universal micrometer rear sight 7002, rubber eyeshade 6700- 20, metal aperture set.  
- Suitable for all common target rifles. 10 clicks.

**Art.-Nr.: 7000070**

20 clicks.

**Art.-Nr.: 7000071**



▲ ANSCHÜTZ SIGHT SET:

- Complete sight set with front sight 6832, Universal micrometer rear sight 6805-10 clicks, rubber eyeshade 6700-20, metal aperture set.  
- Suitable for models 1903 - 2013. 10 clicks.

**Art.-Nr.: 7000060**



▲ PLASTIC FRONT SIGHT INSERT (pink):

- For Anschutz, Feinwerkbau, Walther, Diana, Steyr, M 18, 2.4 - 6.0 mm in steps of 0,1 mm.

**Art.-Nr.: 71015xx**



▲ ANSCHÜTZ UNIVERSAL MICROMETER REAR SIGHT:

- Screws for elevation and windage adjustment.

	10 clicks	20 clicks
10 m	0,4	0,2
50 m	2,2	1,1
100 m	4,4	2,2

**Art.-Nr.: 7000170** 10 clicks.

**Art.-Nr.: 7000171** 20 clicks.



▲ ANSCHÜTZ PRECISION REAR SIGHT:

- With anti-glare tube.  
- Adjustment from click to click 0.5 mm (at 10 m), 2.5 mm (at 50 m).

**Art.-Nr.: 7000115**

Colored knobs  
see page 48.



▲ TRANSPARENT PLASTIC FRONT SIGHT INSERT SET:

- In diameters 3.1 / 3.3 / 3.4 / 3.5 / 3.7 / 3.9 / 4.1 / 4.3 mm.  
- Suitable for Anschutz and Feinwerkbau target rifles.

**Art.-Nr.: 7001500**



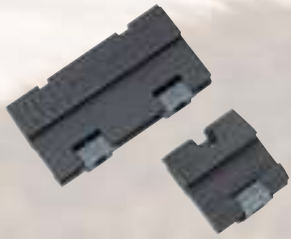

▲ **HIGH SIGHT BLOCK FOR SIGHTING LINE:**

- 10.5 mm off-set prism.
- Easy head posture free of cramps in every firing position.

**Art.-Nr.: 7001231**



▲ **HIGH SIGHT BLOCK FOR SIGHTING LINE:**

- With new clamping.
- Extremely sturdy clamping guarantees perfect fit, therefore also suitable for big bore rifles.
- Fits all current target rifles such as Anschütz, FWB, Diana, Steyr.

**Art.-Nr.: 7001232**



▲ **HIGH SIGHT BLOCK FOR SIGHTING LINE:**

- Suitable for Anschütz Models 1907 to 2013.

**Art.-Nr.: 7006150**



▲ **GRIP PRO-GRIP:**

- Grip adjustment in every possible direction.
- For Anschütz air rifles + small bore rifles.

**Art.-Nr.: 705.7900** Large.

**Art.-Nr.: 705.7905** Medium.



▲ **HANDSTOP with sling swivel:**

- Individually adjustable.

**Art.-Nr.: 7003600**



▲ **HANDSTOP with sling swivel:**

**Art.-Nr.: 7003601**



▲ **SIGHTING LINE EXTENSION 200:**

An optimum combination of sighting line extension and raiser block, especially developed for benchrest shooting. The benchrest shooter looks through the sight set in a completely different way. The sight set is moved back and is higher and thus allows for an optimum adaption to the various positions. 200 mm.

**Art.-Nr.: 7001224**

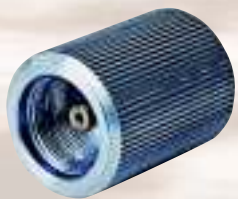

▲ **AIR RELEASE VALVE:**

- To empty the compressed air cylinder.
- Suitable for compressed air cylinders of Model 2002 CA + 9003 Premium.

**Art.-Nr.: 7113408**



▲ **ADAPTER 430-U45 for refill bottle:**

- Adapter for refill bottle and compressed air cylinder with air filter.
- Suitable for compressed air cylinders of Model 2002 CA + 9003 Premium.

**Art.-Nr.: 7113409**



▲ **BARREL WEIGHT 4745:**

- 2 parts.
- Inner-Ø 20 mm, 50 g.

**Art.-Nr.: 7006340**



▲ **WEIGHT RING:**

- 25 g.
- Inner-Ø 12 mm.

**Art.-Nr.: 7113805**



61

# ANSCHÜTZ ACCESSORIES

high quality and accuracy



62



▲ FOREND RAISER BLOCK:

- Model 2213-8500.  
- Height 47 mm, Length 170 mm, colored.

**Art.-Nr.: 7003623** Blue.

**Art.-Nr.: 7003629** Black.

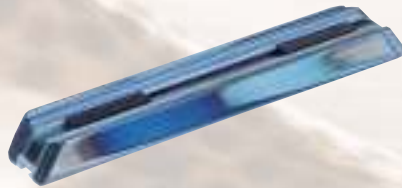

▲ FOREND RAISER BLOCK:

- Model 2213-8550.  
- Height 24 mm, Length 315 mm, colored.

**Art.-Nr.: 7003624** Blue.

**Art.-Nr.: 7003625** Black.

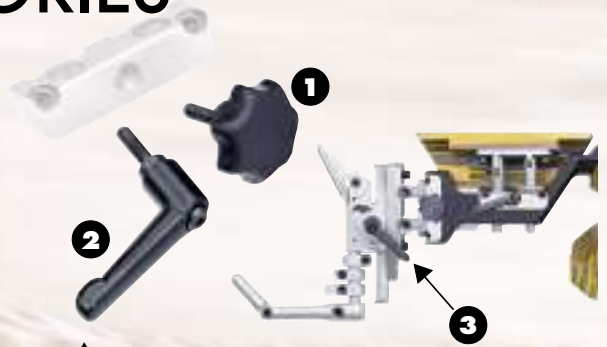

▲ QUICK CLAMPING:

For the new adjustment.

**Art.-Nr.: 7003780** 1

**Art.-Nr.: 7003785** 2

For Hook butt plate 4765.

**Art.-Nr.: 7003790** 3



▲ REFILL ADAPTER:

Especially developed for refill bottles or devices which do not guarantee 100% collection of humidity.

- With humidity filter/dry pellets.  
- Suitable for all brands.

**Art.-Nr.: 7113411**



▲ HOOK BUTT PLATE 2213-8700:

- Complete with hook and guide plate.

**Art.-Nr.: 7003569**



▲ SPIRIT LEVEL:

- To fix position prior to each shot.  
- Supplied without globe front sight.

**Art.-Nr.: 7001302**



▲ SPIRIT LEVEL:

- Supplied without globe front sight.

**Art.-Nr.: 7001301**

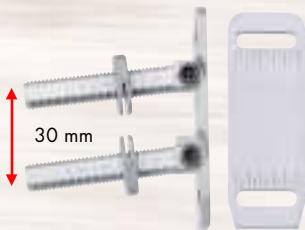

◀ HOOK PLATE CARRIER 2213-8300:

With tilting column guide.

**Art.-Nr.: 7003563**



◀ BI-POD:

- Model 4770.

**Art.-Nr.: 7003440**



◀ BAUER high pressure compressor with condensed water collector:

Very high quality compressor with air filter system, to fill your refill bottle. Technology according to German DIN, VDE, TÜV and UV regulations. Compressor, 200 bar, for 220 V/230 V, 50 HZ, 1,1 kW Air thrupt approx ca. 30 l/min.

**Art.-Nr.: 7113570**

Compressor, 200 bar, for 110 V, 60 Hz, 1,1 kW Air thrupt approx ca. 30 l/min.

**Art.-Nr.: 7113580**



1 GLOBE FRONT SIGHT:

- For Mod. 1907-2013 and air rifle.

**Art.-Nr.: 7000221**



2 GLOBE FRONT SIGHT EXTENSION:

**Art.-Nr.: 7001220**



3 OPTICAL LENS:

- For thread M 18 x 0,5, 0,3 diopter.

**Art.-Nr.: 7101120**

0,5 diopter.

**Art.-Nr.: 7101130**



# The best shooters in the world

rely on ahg-Anschütz shooting jackets and pants



**Dieter Grabner**

- Austria.  
Air rifle, small bore rifle, crossbow
- World Champion.
  - European Champion.
  - Multiple Austrian Champion in various disciplines.
  - Holder of several Austrian Records.
  - Multiple Winner of the Eurocup.
  - World Record Holder.



**Britta Grosseccapenberg**

- Germany.  
Air rifle, small bore rifle.
- Multiple German Champion.
  - Member of the German National team.
  - Bronze medal WC Sydney 2002.



**Christian Klees**

- Germany.  
Small bore disciplines.
- World Cup Winner.
  - Olympic Champion.
  - European Champion.
  - 8 x German Champion.
  - Owner of two World Records, two Olympic Records, four German Records.



**Tino Mohaupt**

- Germany.  
Air rifle
- German Championships 2000 Munich 1st place Junior Air Rifle.
  - IWK 2000 Pilsen 1st place Munich 1st place Luxemburg 1st place
  - European Championships 2001 2nd place.
  - German Team Champion 2003.



**Christian Planer**

- Austria
- Air rifle, small bore rifle and 300 m.
  - Multiple Austrian Champ.
  - Multiple Austrian Record Holder.
  - 3rd place Prone WC Changwon 2002.
  - European Champ. Prone Team 2003.
  - European Champ. 3 Position Team 2003.
  - Vice Europ. Champ. 300 m Prone 2003.
  - 3rd place Europ. Champ. Pilsen 300 m Prone Team 2003.
  - 2nd place Europ. Cup 300 m 3 Position 2003.
  - Bronze Medal 3x40 Olympic Games 2004.



**Leif Steinar Rolland**

- Norway.  
Air Rifle.
- Multiple World Cup Winner.
  - Norwegian Champion.
  - European Champion.
  - Winner of the Final World Cup.
  - Final World Record air rifle.



**Alexandra Schneider**

- Germany.  
Air rifle and small bore rifle.
- European Champion.
  - World Record Holder.
  - German Record Holder.
  - Multiple German Champion.
  - Member of the German National Team.
  - World Cup Winner.



**Harald Stenvaag**

- Norway.  
Air rifle and small bore rifle.
- 6 x European Champion.
  - 3 x World Champion.
  - More than 30 medals in World Cups.
  - Winner of the Final World Cup.
  - More than 50 x Norwegian Champion.
  - Silver medal at the Olympics in 1992.
  - Bronze medal at Sydney in 2000.
  - Bronze medal at the Olympics 2000.



E 3.- Fee  
Your dealer:



**ahg-Anschütz Handels GmbH**  
Raiffeisenstrasse 26  
D-89079 Ulm-Wiblingen/Germany  
Phone (++49) - 731 - 42031  
Phone (++49) - 731 - 42034  
Fax (++49) - 731 - 42033  
Internet [www.anschuetz-sport.com](http://www.anschuetz-sport.com)  
e-mail [ahg-info@anschuetz-sport.com](mailto:ahg-info@anschuetz-sport.com)